

Lochgruppe gemäß Beiblatt 1 zur DIN EN 1154

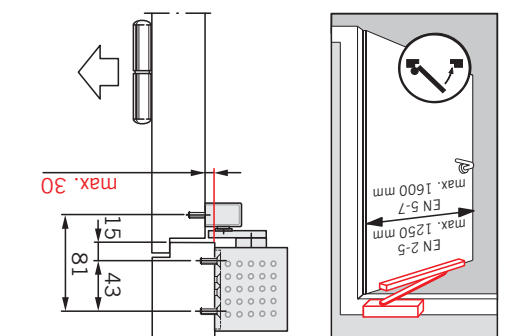

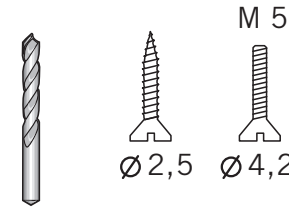

Lochgruppe gemäß Beiblatt 1 zur DIN EN 1154

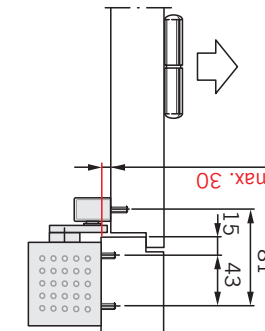
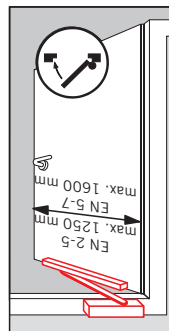
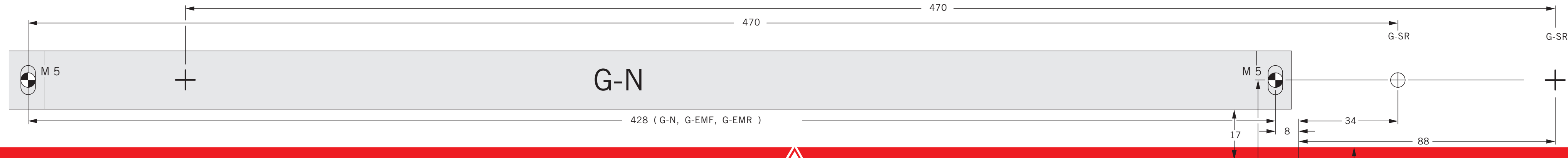
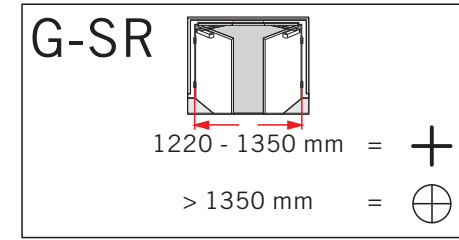

TS 93 B

EN 2-5 / 5-7

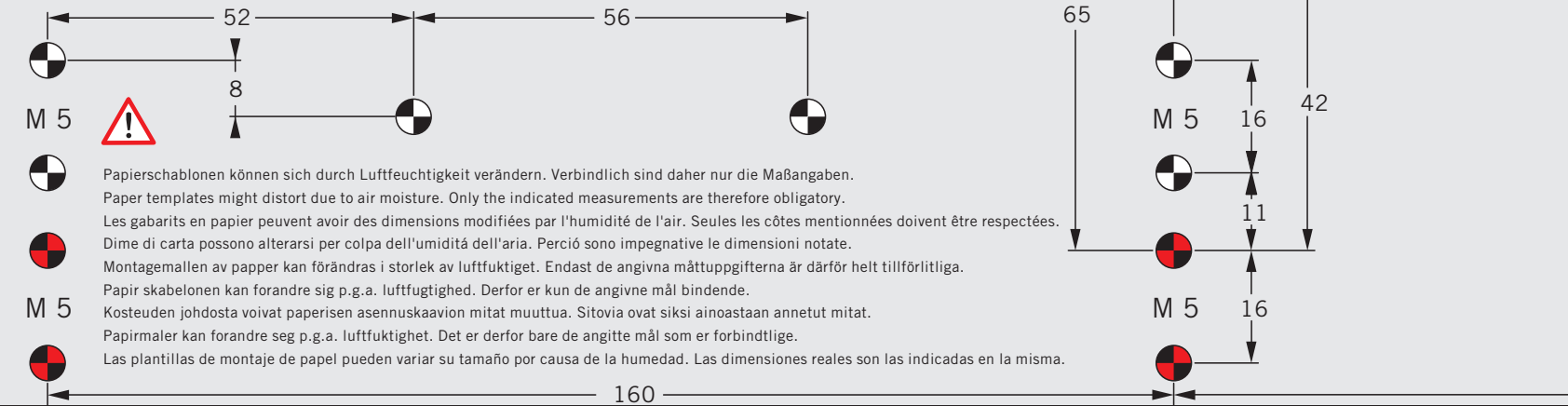

- M 5 **!** Papiersjablonen können sich durch Luftfeuchtigkeit verändern. Verbindlich sind daher nur die Maßangaben. Paper templates might distort due to air moisture. Only the indicated measurements are therefore obligatory. Les gabarits en papier peuvent avoir des dimensions modifiées par l'humidité de l'air. Seules les côtes mentionnées doivent être respectées.
- M 5 Dime di carta possono alterarsi per colpa dell'umidità dell'aria. Perciò sono impegnative le dimensioni notate. Montagemallen av papper kan förändras i storlek av luftfuktighet. Endast de angivna måttuppgifterna är därför helt tillförlitliga. Papir skabelonen kan forandre sig p.g.a. luftfugtighed. Derfor er kun de angivne mål bindende. Kosteuden johdosta voivat paperisen asennuskaavion mitat muuttua. Sitovia ovat siksi ainoastaan annetut mitat. Papirmaler kan forandre seg p.g.a. luftfuktighet. Det er derfor bare de angitte mål som er forbindtlige. Las plantillas de montaje de papel pueden variar su tamaño por causa de la humedad. Las dimensiones reales son las indicadas en la misma.

