

dormakaba four+ lever handle series



The four+ lever handle series

All the benefits at a glance

Design, quality and variety are all hallmarks of four+. The four+ lever handle series includes a wide range of common handle types for public buildings. four+ fittings are available for use in fire and smoke doors, and the corresponding emergency exit handles are certified to EN 179. With its four+ range of fittings, dormakaba proves that economic, cost-efficient solutions can be effectively applied to meet standard design requirements throughout project builds. The fitting series is particularly suitable for use in functional project build doors. four+ fittings are a reliable solution made to the dormakaba quality standard. They are available as complete sets for solid leaf doors with round roses or oval short backplate. Half sets on oval roses are available for profile doors.

From ordering to installation: we make it easy for you

- Lever handles of the four+ series can be used for both right-hinged and left-hinged doors. This simplifies ordering, storage and installation.
- Thanks to our clever product packaging, all the individual parts are visible and easy to remove.
- The pre-installed threaded end saves valuable installation time.

From installation to easy use:

- Four high-performance return springs ensure handles return to 0° horizontal position.
- The fact that this product is classified as the highest category of use grade 4 with a corrosion protection grade of 5 and more than 1 million test cycles speaks to its high quality.



For profile-framed and timber doors 0° horizontal position in normal state

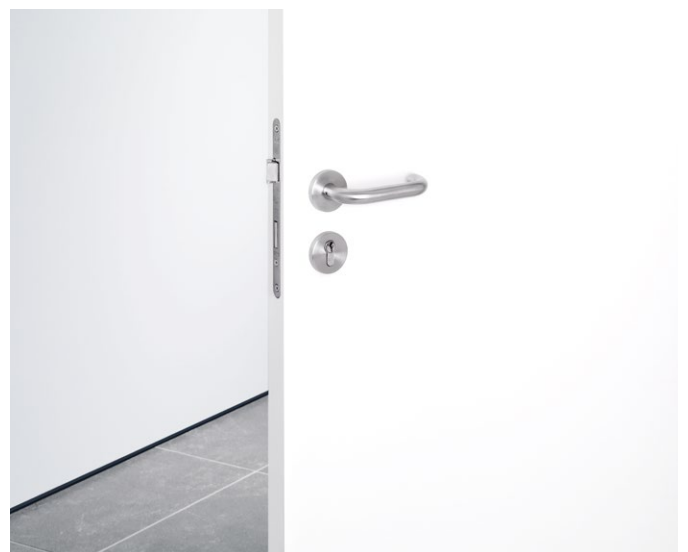

Simply simple: right/left compatibility

For effortless ordering, storage and installation

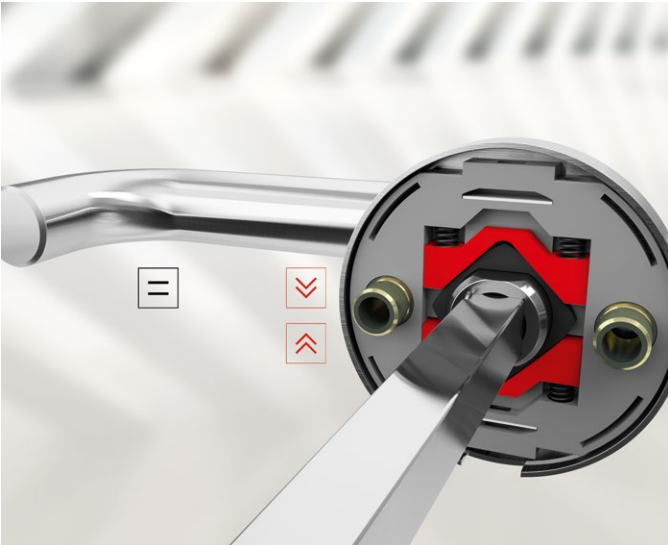

Tension of the return springs



Right/left compatibility



Zero position

Technology that opens doors ... and impresses users

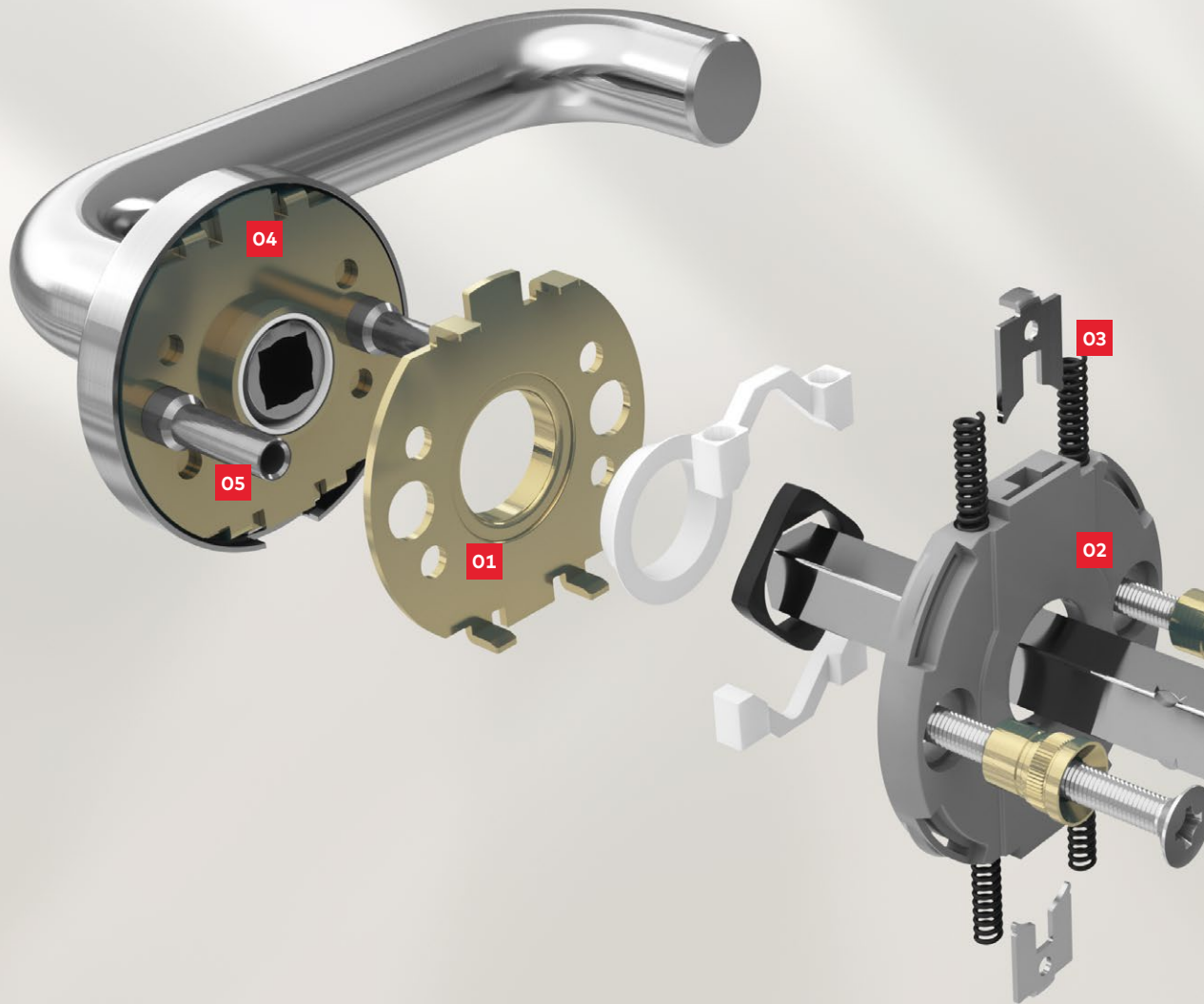

01
Long-lasting functionality thanks to corrosion-protected steel mounting plates
With the steel mounting plates, even strong forces are reliably transmitted to the door leaf, which takes the strain off the set and lock.

02
Robust sleeve bearings for smooth usage in the door
The maintenance-free sleeve bearing reliably absorbs tilting push-and-pull forces, providing precise strain relief for the lock follower.

03
Four return springs for a 0° horizontal position
Four return springs ensure that the lever handles remain horizontal even after intensive long-term use.



04

Easy storage and installation thanks to innovative right/left compatibility

Lever handles of the four+ series can be used for both right-hinged and left-hinged doors. This simplifies ordering, storage and installation.

05

Simple installation with extended support lugs

Long support lugs allow timber door thicknesses of 38–63 mm to be spanned using just a single screw fixing length.

06

Design that moves people and opens doors

Manufactured in stainless steel, lever handles of the four+ series combine high-quality materials with classic design and offer the perfect lever handle solution for any building.

Certified high performance

A reliable choice for public buildings

Satisfies even the highest standards: our own

Establishing international standards is a lengthy process which often takes many years. Developing a product geared to the requirements of conventional standards leaves potential customer benefits out of the equation.

Better than the standard BS EN 1906

The four+ lever handle series significantly exceeds the 200,000 test cycles required by BS EN 1906 to qualify for the highest grade. The four+ lever handles withstood more than 1 million test cycles during a single load test.

BS EN 1906 classification key for four+

	4	7	-	C1*	1	5	0	A**	
Category of use Grade 1: Medium frequency of use by people with a high incentive to exercise care and a small chance of misuse, e.g. internal residential doors Grade 2: Medium frequency of use by people with some incentive to exercise care but where there is some chance of misuse, e.g. internal office doors Grade 3: High frequency of use by public or others with little incentive to exercise care and with a high chance of misuse, e.g. public office doors Grade 4: For use in doors which are subject to frequent violent use or damage, e.g. in football stadiums, offshore structures (oil rigs), barracks, public toilets									
Durability Grade 6: Medium use: 100,000 test cycles Grade 7: High frequency use: 200,000 test cycles									
Door mass No classification									
Fire resistance Grade 0: not approved for use on smoke door assemblies Grade A: suitable for use on smoke door assemblies Grade A1: suitable for use on smoke doors, tested with 200,000 test cycles on a test door Grade B: suitable for use on fire/smoke door assemblies (tested with 200,000 test cycles) Grade B1: suitable for use on smoke and fire doors, tested with 200,000 test cycles on a test door Grade C: suitable for use on smoke and fire doors with requirements for fire dividers in backplate, door rose and escutcheon Grade C1: suitable for use on smoke and fire doors with requirements for fire dividers in backplate, door rose and escutcheon, tested with 200,000 test cycles on a test door Grade D: suitable for use on smoke and fire doors with requirements for a special lever handle core in the handle/knob									
									Type of operation A = spring-assisted fitting B = spring-loaded fitting U = unsprung fitting
									Burglary resistance 0 = no performance specified 1 = minimum burglary resistance 2 = moderate burglary resistance 3 = high burglary resistance 4 = extra-high burglary resistance
									Corrosion resistance 0 = no corrosion resistance 1 = minimum corrosion resistance 2 = moderate corrosion resistance 3 = high corrosion resistance 4 = very high corrosion resistance 5 = extra-high corrosion resistance
									Safety and security Grade 1: Safety applications

* Stainless steel version: Grade C1.

** Operation type "U" for passive door leaves on request.

Data and features

at a glance

Data and features		Sets for	
		Timber doors	Profile-framed doors
Return springs		+	+
Return springs, right/left compatible		+	+
Fixed pivoting bearing on threaded side (factory pre-assembled)		+	+
Category of use	BS EN 1906	4	4
Certified for doors in escape routes	BS EN 179:2008	●	●
Tested to	BS EN 1634-1*	+	+
Certified for fire and smoke doors	German Industrial Standard (DIN) 18273	+	+
Environmental product declaration according to ISO 14025, declaration holder: Institut Bauen und Umwelt e.V.		+	+
Steel mounting plates		+	+
Extended support lugs on the mounting plates		+	–
Identical screw length for the entire door thickness range		38 – 63	
Screw attachment through the door		+	–
Maintenance-free slide bearing		+	+
Sets	Normal sets	+	+
	Knob/lever handle sets	+	+
	WC sets	+	–
Material	Stainless steel, matt	+	+

+ Yes – No ○ Optional ● Approvals depending on lever handle model

* For use on fire and smoke doors, national standards may additionally need to be complied with.

The right lever handle for any door

For both profile-framed and timber doors

four+ 104



four+ 116



four+ 120



four+ 124



four+ 204



Round rose or short backplate

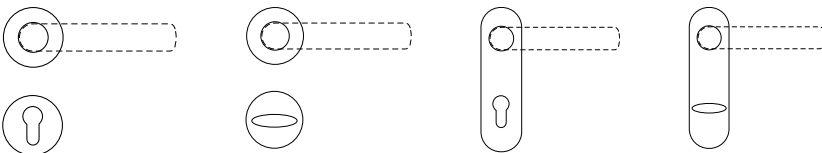

Lever handles of the four+ series are available for timber doors with a round rose or short backplate.

Delivery as a complete set with return spring including mounting material and spindle (for door thicknesses of 38–63 mm).

Accessory pack required for door thicknesses of 64–110 mm. No spindle is included with half sets.

Full sets with PZ perforation (7100006x article numbers) include 8mm and 9mm spindles, with enclosed reducing sleeve.

See price list for separate article numbers for individual 8mm and 9mm sets.

four+ 112

F **E** ■



four+ 108

F **E** ■

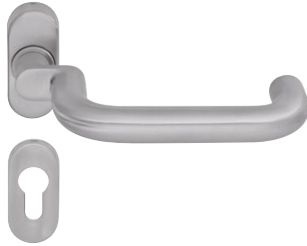

four+ 216

F ■

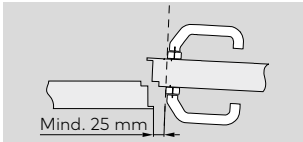

Please note: A minimum clearance of 25 mm must be maintained between the lever handle and the opposing closing edge.
Delivery of lever handles on oval rose with return spring. Spindle must be ordered separately.
Without mounting material.

-
- F** BS EN 1634-1: Fire resistance tests for doors
 - DIN 18273: Lever handle sets for fire and smoke doors
 - E** BS EN 179: Emergency exit application with lever handles
 - Stainless steel



Lever handle sets for timber doors

four+ 104

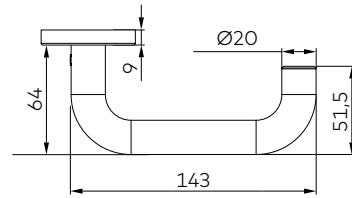

71000061



71000060



71000006



71000001



71000062



71000063



71000105



71000110



71000100



71000101

four+ 116

F ■

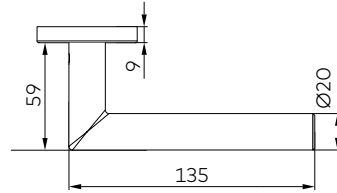

71000065



71000064



71000016



71000011



71000066

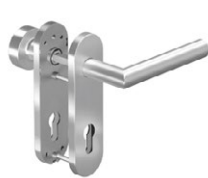

71000067

F BS EN 1634-1: Fire resistance tests for doors
DIN 18273: Lever handle sets for fire and smoke doors
E BS EN 179: Emergency exit application with lever handles
■ Stainless steel



Lever handle sets for timber doors

four+ 120

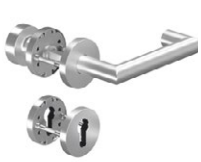
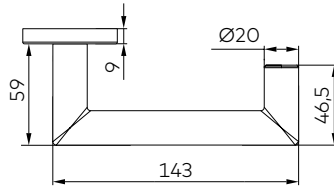

71000073



71000072



71000044

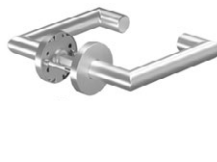

71000031



71000074



71000075

four+ 124

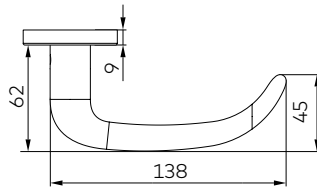

71000069



71000068



71000026



71000021



71000070



71000071

Lever handle sets

for profile-framed doors

four+ 112

F **E** ■

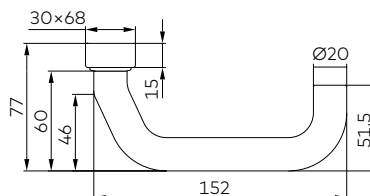

71000620



71000622



71000661

four+ 108

F **E** ■

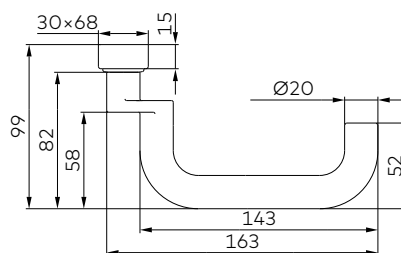

71000619



71000621



71000660

four+ 216

F ■

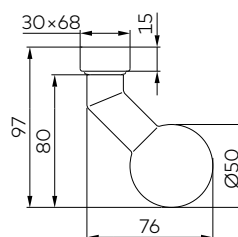

71000604



71000605

F BS EN 1634-1: Fire resistance tests for doors
 DIN 18273: Lever handle sets for fire and smoke doors
E BS EN 179: Emergency exit application with lever handles
 ■ Stainless steel



Roses and backplates

For both profile-framed and timber doors

Round roses for timber doors

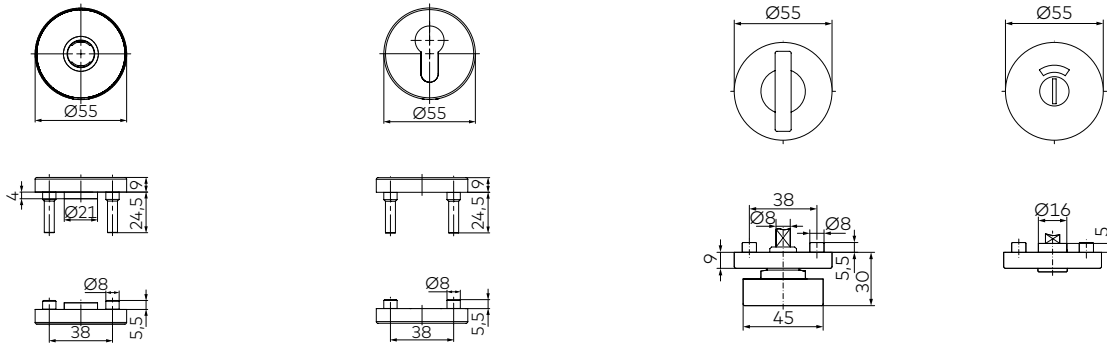

Oval roses for profile-framed doors



Backplates for timber doors

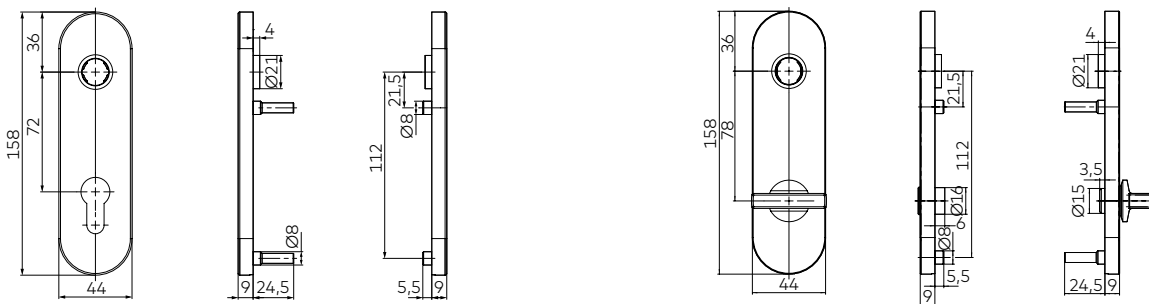

Punched holes for escutcheons and backplates

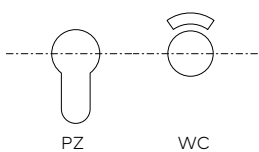

Also available without punched holes (UN). Other punched holes and hole removal on request.
For spindles see price list.

Door solutions from a single source

In addition to your four+ door fitting



dormakaba is your partner for a comprehensive product and solutions portfolio around the door. For your four+ door fitting, you can also obtain from dormakaba complementary door components. For example, self-locking panic locks (SVP), mechanical locking cylinders or electronic digital cylinders. You can receive these, and other products and services for your individual door solutions from a single source.

Service. For your security.

We take care of the security and performance of your infrastructure and offer a premium service around the topic of access to your building.

Your advantages:



Installation



Training



Maintenance



Updates & Consulting



Repair



Genuine spare parts



Modernisation & Upgrades

Self-locking panic locks

Automatically lock doors after each closing, mechanically or motor-controlled, network-compatible - security in both directions, convenient and safe.

The panic function allows the door to be opened in the direction of escape at any time by simply operating the lever handle. Furthermore, mechanical opening via the profile cylinder from the outside is possible at any time.

Mechanical lock cylinders

The simplest and safest way to protect your property is to use mechanical locking cylinders. In addition to the choice of different surface colors, here you can also configure different security features or functions according to your needs.

Electronic access control with dormakaba digital cylinders

Digital cylinders are smart, standalone electronic locking cylinders. Use smart keys, ID cards and smartphones as access media and delete authorizations at will. Authorization management allows maximum flexibility and security. Integration into higher-level access control systems and mechanical locking systems is possible at any time.

Our Sustainability Commitment

We are committed to foster a sustainable development along our entire value chain in line with our economic, environmental and social responsibilities toward current and future generations. Sustainability at product level is an important, future-oriented approach in the field of construction. In order to give quantified disclosures of a product's environmental impact through its entire life cycle, dormakaba provides Environmental Product Declarations (EPD), based on holistic life cycle assessments.

www.dormakaba.com/sustainability



Our offering

Access Automation Solutions

Entrance Automation
Entrance Security



Access Control Solutions

Electronic Access & Data
Escape and Rescue Systems
Lodging Systems



Access Hardware Solutions

Door Closers
Architectural Hardware
Mechanical Key Systems



Services

Technical Support
Installation and commissioning
Maintenance and Repair



WN 05585451532, 07/24
Subject to technical modifications without notice



dormakaba.com

dormakaba
International Holding AG
Hofwissenstrasse 24
CH-8153 Rümlang
T +41 44 818 90 11
info@dormakaba.com
dormakaba.com