

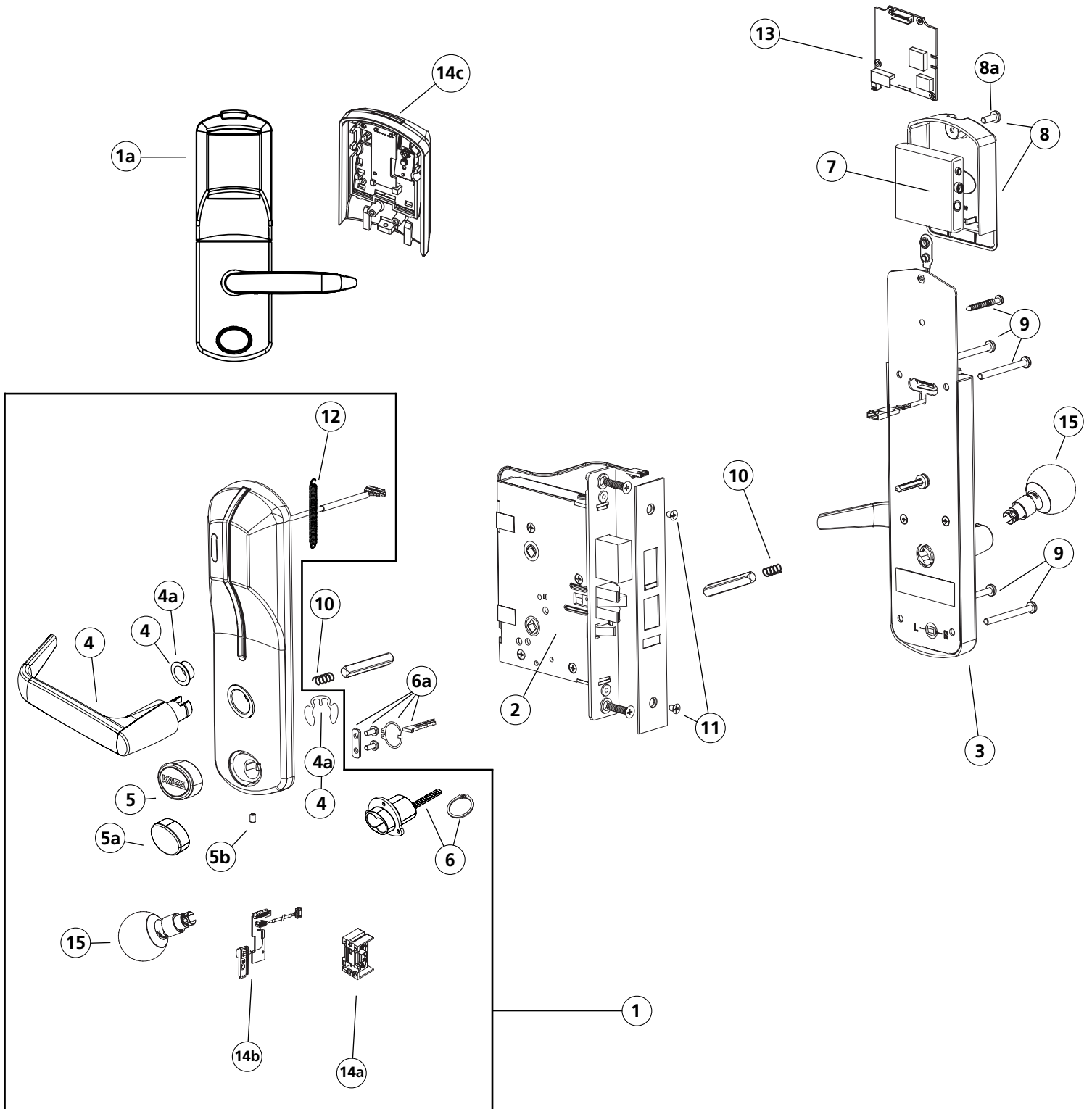

Lock Replacement Parts

SolitaireSMART & 710-II
Mortise (Standard & Slim)



Lock Replacement Parts

SolitaireSMART & 710-II Series

Standard Mortise & Slim Mortise

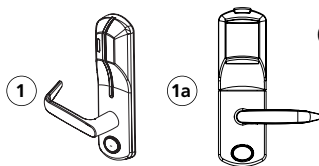

Outside Lock Housing

Includes: Outside housing, lever, reader, medallion, medallion set screw, override adapter. Core not included.

Build the model number with the desired options

F /

Lock Type Track Lever Override Handing Version Door Thickness Type Finish

Lock Type	Track	Lever	Override	Handing	Version	Door Thickness	Type	Finish	
F71 Solitaire 710-II	1 2 3	1 Long	Override E External Electrical Battery Backup K Mechanical Key core Lori Universal (1539) key-in-knob housing Removable Core U Ilco adapter B Best 6 or 7 pin Adapter M Medeco 6 pin cylinder Adapter	L Left Hand/ Left Hand Reverse R Right Hand/ Right Hand Reverse	3 Solitaire 710-II with Thrift & Ilco Format Reader	0 1 3/8" - 2 1/2" (35 - 66 mm)	N	A Standard Plated*	626 Satin Chrome 606 Satin Brass 222 Painted Black with Satin Chrome lever and Medallion 223 Painted Black with Satin Brass lever and Medallion 446 Painted Silver with Satin Chrome lever Optional 612 Satin Bronze 613 Oil Rubbed Bronze (simulated)
		Y Refurbished Standard Plated (if available in inventory)						- (Dash) Ultra Plated** Z Refurbished Ultra Plated (if available in inventory)	
F74 Solitaire SMART (Not available for outdoor applications)	/ 1 2 3	1 Long	Select override above.	L Left Hand/ Left Hand Reverse R Right Hand/ Right Hand Reverse	1 Solitaire SMART with Ilco Format Magnetic Encoding	0 1 3/8" - 2 1/2" (35 - 66 mm)	N	- (Dash) Standard Plated	626 Satin Chrome 606 Satin Brass Optional 625 Bright Chrome 605 Bright Brass (PVD) 612 Satin Bronze
		2 Short						0 None	
	3	A Spherical Knob							
	D	D Decorative							
	D	D Dummy Trim (No Reader)							

Note: * Lock does not include weather gasket. Must be purchased separately for outdoor applications & recommended for severe indoor weather conditions.
** Intended for severe outdoor condition (Includes: weather gasket and solid brass cover).



Lock Replacement Parts

SolitaireSMART & 710-II Series

Standard Mortise & Slim Mortise

2 Mortise Latch

Includes: Mounting screws, faceplate and faceplate screw. Strike not included.

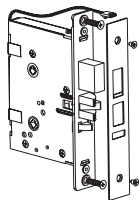

Build the model number with the desired options

M

Model Type Faceplate Deadbolt Handing Lever Switch Finish Refurbished

Model		Latch Type	Faceplate	Deadbolt	Handing		Lever Switch	Finish - Faceplate	Refurbished	
M71	-	A Standard Mortise (AMM)	1 1 1/4" (32 mm)	D With Deadbolt	L Left Hand	2	S Outside Lever Switch	-	Z Refurbished (if available in inventory)	
			2 1" (25 mm)							
		E Slim Mortise (SMM)	3 13/16" (20 mm) round	N Without Deadbolt	R Right Hand	X Left Hand Reverse	N No Outside Lever Switch (Only for electrical override and shabbat lock)			626 Satin Chrome & Painted lock
			4 13/16" (20 mm) square							K No Deadbolt with Privacy kick off
		5 29/32" (23 mm) round	T Auto Deadbolt for AMM Mortise only	Y Right Hand Reverse			Optional for 710-II only			
		0 None						612 Satin Bronze		
								613 Oil Rubbed Bronze (Simulated)		
								000 None		

Note: Refer to Lock Accessories for Mortise faceplate options available.

Lock Replacement Parts

SolitaireSMART & 710-II Series

Standard Mortise & Slim Mortise

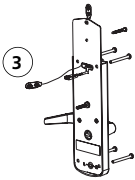

Inside Lock Housing

Note: For Shabbat Lock add "S" between 0 and - (Dash).

Includes: Complete Inside Housing with lever, gasket and battery cover. Batteries sold separately.

Build the model number with the desired options

B /







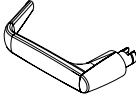

Lock Type Privacy Lever Key Override Handing Version Shabbat Finish Refurbished

Lock Type	Privacy	Lever	Key override	Handing	Version				Finish	Refurbished
B71 Solitaire 710-II	/ T Auto-deadbolt, with Privacy Thumbturn P With Privacy Thumbturn N Without Privacy Thumbturn ----- D Dummy Trim	1 Long 2 Short A Spherical Knob D Decorative	K With Key Override E (Electrical) Without key override	L Left Hand/ Left Hand Reverse R Right Hand/ Right Hand Reverse	3 Thrift & Ilco Format Reader Board	0	-	606 Satin Brass 626 Satin Chrome 222 Black Paint with Satin Chrome Lever and Thumbturn 223 Black Paint with Satin Brass Lever and Thumbturn 446 Silver Paint with Satin Chrome Lever and Thumbturn Optional 605 Bright Brass (PVD) 612 Satin Bronze 613 Oil Rubbed Bronze (Simulated) 625 Bright Chrome Note: ATLAS Upgrade program Refurbished (Z) Upgrade Option (for B71): If replace / with @, Inside Lock Housing comes with Thrift / Ilco Format New Reader (Track 3) for the outside lock housing at an attractive price.	Z Refurbished (if available in inventory)	
			N N/A							
B74 Solitaire SMART	/ T For auto deadbolt, with Privacy Thumbturn P With Privacy Thumbturn N Without Privacy Thumbturn ----- D Dummy Trim	1 Long 2 Short A Spherical Knob D Decorative	K With Key Override E (Electrical) Without key override	L Left Hand/ Left Hand Reverse R Right Hand/ Right Hand Reverse	1 Ilco Format Reader Board 2 Ilco Format Reader Board with Gasket housing	0	-	606 Satin Brass 626 Satin Chrome		
			N N/A							



Lock Replacement Parts

SolitaireSMART & 710-II Series
Standard Mortise & Slim Mortise









Item	Descriptions	Part#
4	Outside Lever Includes: Retaining ring 5/8" and nylon bearing	
	 Long Right Handed	069-508555-xxxK
	Left Handed	069-508312-xxxK
	 Short Right Handed	069-509269-xxxK
	Left Handed	069-509299-xxxK
	Decorative Right Handed	068-511183-RxxxK
	Left Handed	068-511183-LxxxK
4a	 Nylon Bearing, Retaining ring Note: Replace XXX by finish	062-510296
5	Medallion	
	 Includes: Set screw With Kaba logo	062-510436-xxxK
	Without Kaba logo	069-508934-xxxK
5a	Custom Tooling Custom Engraved	Call factory Call factory
	Gasket (foam pad) Kit - for SolitaireSMART (place inside medallion) 10/pack	033-510033-K
5b	 Set Screw Pack	941-507642-K
6	Connection Bar  Ilco core adapter connection bar Includes: Connection bar, C-Clip, Foam Spacer	062-510297-K
6a	Key Override Assembly Kit - Lori Key-in-Knob Core  Plate Bridge, Two 8-32 x 1/4" (14 mm) Phillips head screw, Retaining Ring - reinforced, Connection bar	128-509675-K
7	Battery Battery Pack	118-509141-10
8	Battery Cover Black Battery Cup with mounting screw	118-509323-622K
8a	Battery Screw Mounting Screw Pack	840-508711-K
9	Mounting Screw Pack Includes: 4 mounting screws and 1 screw for wood door Replace Y with door thickness and XXX with finish	062-509899-Yxxx
	Door Thickness: 1 1 3/8" - 1 1/2" 2 1 5/8" - 1 3/4" 3 1 7/8" - 2" 4 2 1/8" - 2 1/4" 5 2 3/8" - 2 1/2"	(35 - 40 mm) (41 - 46 mm) (47 - 52 mm) (53 - 58 mm) (59 - 65 mm)
10	Compression Spring Pack (Spindle)  Lock requires 2 springs	012-509135-K

Lock Replacement Parts

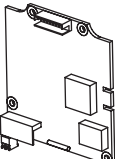
SolitaireSMART & 710-II Series

Standard Mortise & Slim Mortise



Item	Descriptions	Part#
11	 Mortise Face Plate Screw Pack Replace XXX by Face Plate Finish	062-508656-xxxK
12	 Lever Extension Spring Pack Solitaire 710-II Outside Housing SolitaireSMART Outside Housing	012-507220-K 012-510128-K
13	 PCB Lock Controller Board For Solitaire 710-II For SolitaireSMART	064-510464-001 064-511440-007
14a	 Card Reader For Solitaire 710-II Track 1 Track 2 Track 3	064-511401-1 064-511401-2 064-511401-3
14b	 SolitaireSMART Track 1 Track 2 Track 3	118-509524-1 118-509524-2 118-509524-3
14c	 SolitaireSMART Reader Module Replace Y by track and XXX by finish	118-509288-Yxxx
15	 Knob Assembly (Inside/Outside) Includes: spindle, retaining ring, springs, sleeve and insert Satin Chrome Satin Brass Bright Brass	062-510479-626 062-510479-606 062-510479-605
	Drilling Plate For electrical override locks shipped after May 2002. Replace plate after drilling for Emergency Entry.	061-510019-K
	 Strike Screw Pack Replace XXX by desired finishes: Satin Brass (606), Satin Chrome (626).	062-504155-XXX
	Cable Kit For Solitaire 710-II/SMART Includes: Override Switch (left and right hand) Battery Snap Assembly Mortise Harness Assembly	064-511439



Lock Replacement Parts

SolitaireSMART, 710-II Series (Cylindrical)

Exploded View

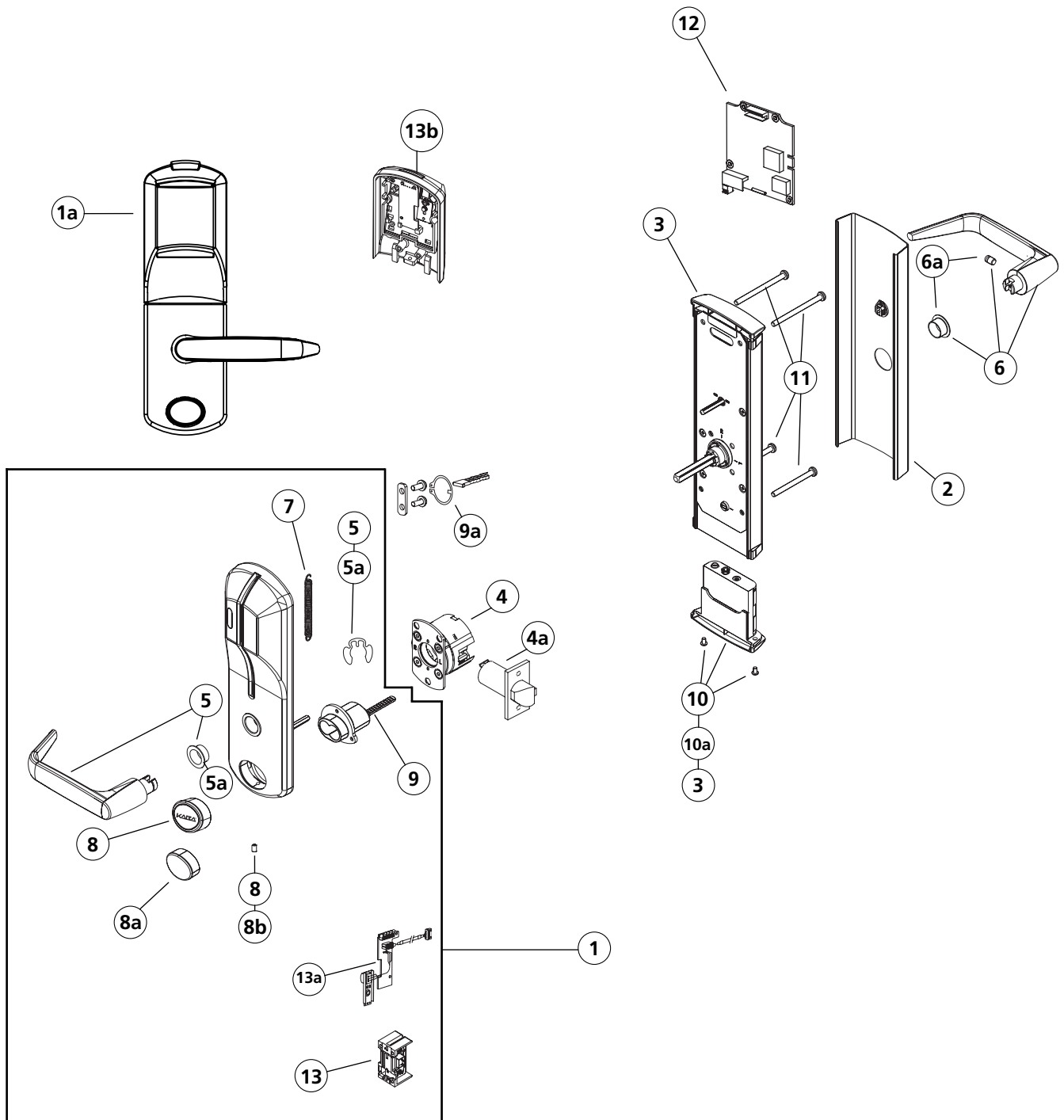

Lock Replacement Parts

SolitaireSMART, 710-II Series (Cylindrical)

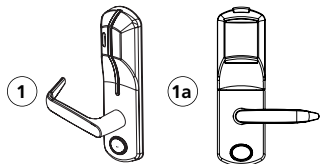

Outside Lock Housing

Includes: Complete Outside Housing with lever, reader, medallion, medallion set screw, and override adapter. Core not included.

Build the model number with the desired options

F /

Lock Type Track Lever Key Override Handing Version Door Thickness Drive Type Finish

Lock Type	Track	Lever	Key Override	Handing	Version	Door Thickness	Drive	Type	Finish
F71 Solitaire 710-II	/	1 Long	Override E External Electrical Battery Backup K Mechanical Key core Lori Universal (1539) key-in-knob housing Removable core U Ilco adapter B Best 6 or 7 pin cylinder adap- tor M Medeco 6 pin cylinder adaptor	L Left Hand/ Left Hand Reverse R Right Hand/ Right Hand Reverse	3 Solitaire 710-II with Thrift & Ilco Format Reader	0 1 3/8" - 2 1/2" (35-65 mm) ----- Unit shipped to fit door thickness in bold . 1 1 3/8" - 1 1/2" (35-40 mm) 2 1 5/8" - 1 3/4" (41-46 mm) 3 1 7/8" - 2" (47-52 mm) 4 2 1/8" - 2 1/4" (53-58 mm) 5 2 3/8" - 2 1/2" (59-65 mm) V Variables <i>Variables to be used only when cylindrical unit is not centered in the door or door thickness is greater than 2 1/2" (66 mm).</i>	N Cylindrical Unit not included ----- C Cylindrical Unit included	A Standard Plated*	626 Satin Chrome 606 Satin Brass 222 Painted Black with Satin Chrome levers and medallion 446 Painted Silver with Satin Chrome levers Optional 612 Satin Bronze 613 Oil Rubbed Bronze (simulated)
		2 Short 3 Short							L Left Hand/ Left Hand Reverse R Right Hand/ Right Hand Reverse
F74 Solitaire SMART (Not available for outdoor applications)	1 2 3	1 Long 2 Short			L Left Hand/ Left Hand Reverse R Right Hand/ Right Hand Reverse	1 Solitaire SMART with Ilco Format Magnetic encoding			- (Dash) Standard Plated

Note: * Lock does not include weather gasket. Must be purchased separately for outdoor applications & recommended for severe indoor conditions.
 ** Intended for severe outdoor conditions (Includes: weather gasket and solid Brass cover).



Lock Replacement Parts

SolitaireSMART & 710-II Series (Cylindrical)

② Inside Housing Lock Cover



Build the model number with the desired options					
V 71	-	<input type="checkbox"/>	0	-	<input type="checkbox"/> <input type="checkbox"/> <input type="checkbox"/>
		Privacy			Finish
		Privacy			Finish
	-	P With Privacy Thumbturn	0	-	626 Satin Chrome
		N Without Privacy Thumbturn			606 Satin Brass
					Optional 625 Bright Chrome
					605 Bright Brass
					612 Satin Bronze

③ Inside Lock Housing



Note: For Shabbat Lock, Insert "S" after door thickness.
Includes: Gasket

Build the model number with the desired options											
B	7	/	C	<input type="checkbox"/>	<input type="checkbox"/>	<input type="checkbox"/>	<input type="checkbox"/>	<input type="checkbox"/>	<input type="checkbox"/>	<input type="checkbox"/>	<input type="checkbox"/>
Lock Type			Privacy	Key Override	Handing	Version	Door Thickness	Refurbished			
Lock Type			Privacy	Key Override	Handing	Version	Door Thickness	Refurbished			
B71 Solitaire 710-II	/	C	P With Privacy Thumbturn	K With Key Override	L Left Hand/ Left Hand Reverse	1 Solitaire 710-II with Thrift & Ilco	Unit shipped to fit door thickness in bold .	Z Refurbished (if available in inventory)			
			N Without Privacy Thumbturn No Deadbolt	N Without Key Override	R Right Hand/ Right Hand Reverse	Format Reader Board	1 1 3/8" - 1 1/2" (35-40 mm)				
			Q Privacy with Electrical Kick-Off For 716 Model only				2 1 5/8" - 1 3/4" (41-46 mm)				
							3 1 7/8" - 2" (47-52 mm)				
							4 2 1/8" - 2 1/4" (53-58 mm)				
							5 2 3/8" - 2 1/2" (59-65 mm)				
							V Variables				
B74 SolitaireSMART						1 Solitaire SMART with Ilco Format Reader Board	<i>Variables to be used only when cylindrical unit is not centered in the door or door thickness is greater than 2 1/2" (66 mm).</i>				

Lock Replacement Parts

SolitaireSMART, 710-II Series (Cylindrical)



4 Cylindrical Unit & Latch



Build the model number with the desired options							
C 71	/	<input type="checkbox"/>	<input type="checkbox"/>	0	<input type="checkbox"/>	-	<input type="checkbox"/> <input type="checkbox"/> <input type="checkbox"/>
Model		Latch	Handing	Door Thickness			Finish

Model	Latch	Handing	Door Thickness	Finish
C71	0 No Latch 1 1/2" (13 mm) 2 3/4" (70 mm) backset 2 5/8" (16 mm) 2 3/4" (70 mm) backset 3 3/4" (19 mm) 2 3/4" (70 mm) backset	L Left Hand/ Left Hand Reverse R Right Hand/ Right Hand Reverse	0 Unit shipped to fit door thickness in bold . 1 1 3/8" - 1 1/2" (35-40 mm) 2 1 5/8" - 1 3/4" (41-46 mm) 3 1 7/8" - 2" (47-52 mm) 4 2 1/8" - 2 1/4" (53-58 mm) 5 2 3/8" - 2 1/2" (59-65 mm) V Variables <i>To be used only when cylindrical unit is not centered in the door or door thickness is greater than 2 1/2" (66 mm).</i>	- 000 Specify 000 when no latch is required. 626 Satin Chrome 606 Satin Brass

















4a Cylindrical Latch

Item	Description	Part#
	1/2" (13 mm) 2 3/4" (70 mm) backset	55071-XXX-K
	1/2" (13 mm) 2 3/8" (60 mm) backset (not UL fire rated, not grade 1)	062-510335-XXX
	5/8" (16 mm) 2 3/4" (70 mm) backset	201961-XXX-K
	3/4" (19 mm) 2 3/4" (70 mm) backset	201144-XXX-K
Replace XXX by finish: Satin Brass (606), Satin Chrome (626).		



Lock Replacement Parts

SolitaireSMART & 710-II Cylindrical Unit

Item	Descriptions	Part#
5	Lever Outside  Includes: Lever, nylon bearing, retaining Ring ^{5/8"} Long Replace XXX by finish	062-510011-XXX
	Short Replace XXX by finish	062-510013-XXX
5a	Nylon Bearing, Retaining Ring 	062-510296
6	Lever Inside  Includes: Lever, set screw, nylon bearing Long Replace XXX by finish	062-510012-XXX
	Short Replace XXX by finish	062-510014-XXX
6a	 Includes: Set screw, nylon bearing	062-510511
7	Lever Extension Spring Pack  Solitaire 710-II Outside Housing SolitaireSMART Outside Housing	012-507220-K 012-510128-K
8	Medallion  Includes: Set screw With Kaba Logo	062-510436-xxxK
	Without Kaba logo	069-508934-xxxK
	Gasket (foam pad) Kit - for SolitaireSMART (place inside medallion) 10/pack	033-510033-K
8b	 Set screw Pack	941-507642-K
9	Connection Bar  Iico core adapter connection bar Includes: Connection bar, retaining ring, foam spacer	062-510297-K
9a	Key Override Assembly Kit - Lori Key-in-Knob Core  Plate Bridge, Two 8-32 x 1/4" (14 mm) Phillips head screw, Retaining Ring - reinforced, Connection bar	128-509675-K
10	Battery  Battery Pack / Holder Assembly Includes: 4 AA sealed batteries, 2 screws	118-508847-10
10a	 Battery Holder Screw Pack	840-506186-K
11	Mounting Screw Pack  1 1 3/8" - 1 1/2" (35-40 mm) 2 1 5/8" - 1 3/4" (41-46 mm) 3 1 7/8" - 2" (47-52 mm) 4 2 1/8" - 2 1/4" (53-58 mm) 5 2 3/8" - 2 1/2" (59-65 mm) Replace X by door thickness	062-510455-X
12	PCB Lock Controller Board  For Solitaire 710-II For SolitaireSMART	064-510464-001 064-511440-007
13	Card Reader  Track 1 Track 2 Track 3	Solitaire 710-II 064-511401-1 064-511401-2 064-511401-3
		SolitaireSMART 118-509524-1 118-509524-2 118-509524-3
		SolitaireSMART Reader Module 118-509288-Yxxx Replace Y by track and XXX by finish
	Drilling Plate For electrical override locks shipped after May 2002. Replace plate after drilling for Emergency Entry.	061-510019-K
	Strike Screw Pack  For all strike sizes Replace XXX by finish	062-504155-XXX