

dormakaba YG80 Quick Start Guide

- Wiring the lock requires at least three connections; red (positive), black (negative), and blue (control).
- Ensure the strike magnet is located at the correct position in the strike for the chosen installation orientation.
- Ensure the power supply has the following current available to power the lock when supplied with the following; 2.0A for 24VDC supply with the heater on, 0.5A for 24V supply with the heater off, and 1.0A for 12VDC supply with the heater off.
- Use an appropriate wire gauge for the wire run distance between the lock and power supply.
- Do not mount the lock operating upwards.

Warranty Information

The product is covered by a 3-year manufacturers' warranty against faulty or malfunctioning parts, components, or product. A faulty product can be returned at the customers' expense to the seller for review. At the seller's discretion, either a replacement lock or affected part will be supplied to remedy the fault. Installing the lock in a way that will lower the integrity of the sealing characteristics of the lock may void the warranty. Mistreatment or ill-use of the lock may void the warranty.



Installation and Operating Instructions Download

Package Contents



Lock, Strike, Wire Loom, Neoprene Gasket (Optional)

Product Dimensions

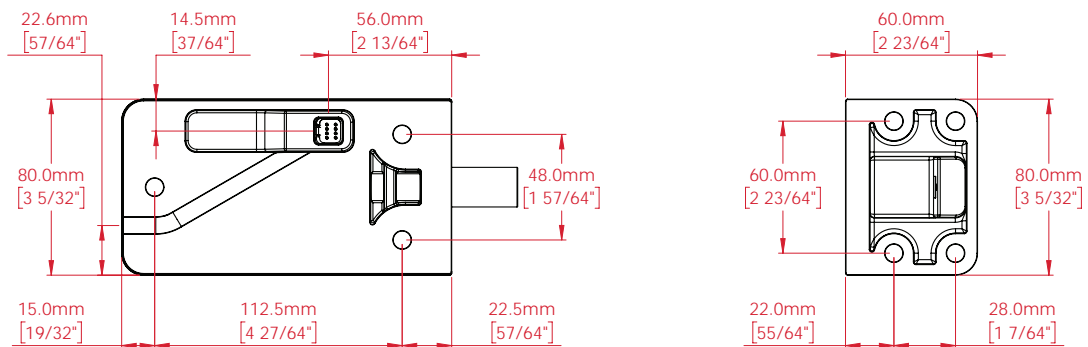

How to set the operating mode.

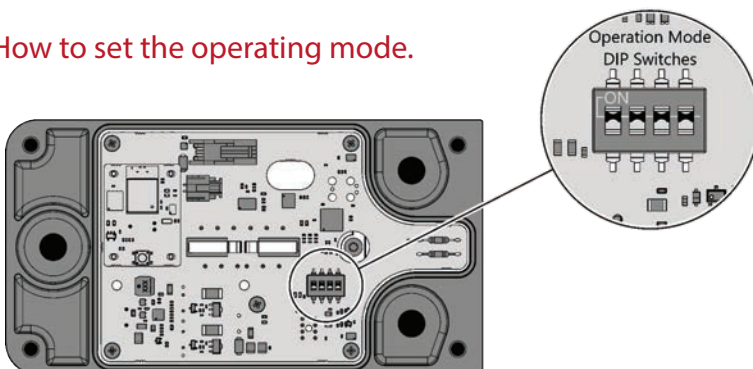

Dip Switch #				Description
1	2	3	4	
OFF	OFF	X	X	Normal Mode Operation
OFF	ON	X	X	Toggle Mode Operation
ON	OFF	X	X	Twin Wire Mode Operation
ON	ON	X	X	Diagnostic Mode Operation
X	X	OFF	X	Fail Safe Mode
X	X	ON	X	Fail Secure Mode
X	X	X	OFF	Heater Off
X	X	X	ON	Heater On (Requires 24VDC)

Locate the dip switches on the product, then set as per table shown.

Toggle the dip switch on the product before powering up.

Strike Configuration - Disassembly

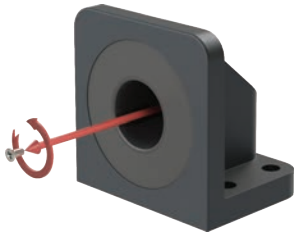

Remove the screw securing the strike ring with a #2 Phillips screwdriver

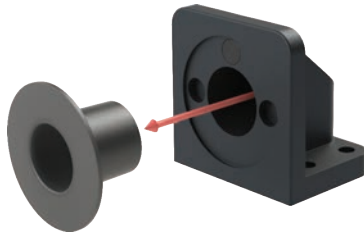

Slide the strike ring off of the strike to reveal the magnet

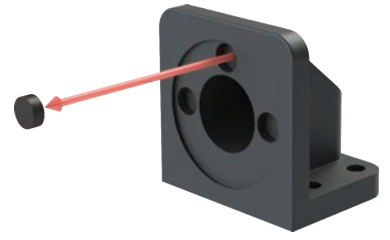

Carefully remove the exposed magnet by tipping the strike over, or using the tip of the screwdriver

Strike Configuration - Assembly

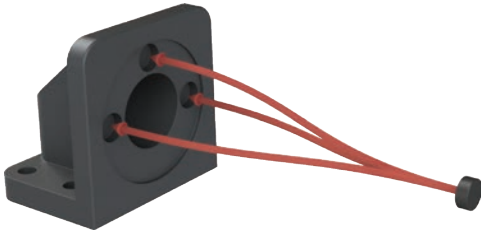

Insert the magnet into the appropriate hole based on the following configuration options, then fit the strike ring back into position and screw in to secure

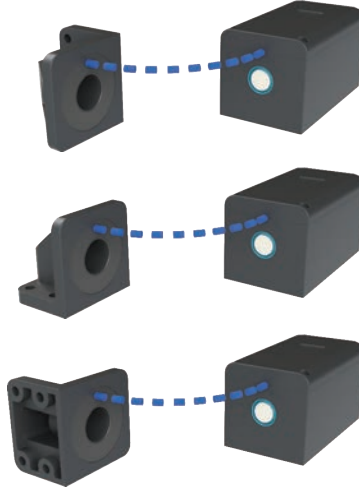

When the strike is oriented 90 degrees counter-clockwise to the lock, the magnet should be in the right slot

When the strike is oriented in the same plane as the lock, the magnet should be in the top slot

When the strike is oriented 90 degrees clockwise to the lock, the magnet should be in the left slot

Wiring Gauge Table

Conductor Cross Sectional Area		Maximum Distance	
#AWG	(mm ²)	at 12VDC	at 24VDC
24	0.20	10m (33ft)	30m (98ft)
22	0.33	16m (52ft)	48m (157ft)
20	0.52	26m (85ft)	77m (253ft)
18	0.82	41m (135ft)	122m (400ft)
16	1.31	65m (213ft)	195m (640ft)
14	2.08	103m (338ft)	310m (1017ft)

Wiring IO Table

Wire Colour	Meaning	Description
RED	Power Supply (12 - 24VDC)	Positive connection to DC power supply, "+"
BLACK		Negative connection to DC power supply, "-", common contact for monitors
BLUE	Control 1	Switched positive control input
BROWN	Control 2	Switched positive control input, for twin wire mode
PURPLE	Door Position	Normally open contact (NO), closed when the strike is aligned with the lock
ORANGE	Bolt Locked	Normally open contact (NO), closed when the bolt is extended
YELLOW	Bolt Unlocked	Normally open contact (NO), closed when the bolt pin is retracted
GREEN	Tamper Detection	Normally closed contact (NC), open when the lid is removed or wires cut

How to wire the lock for each operating mode.

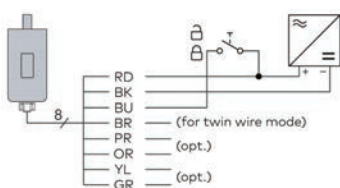

Normal Mode Wiring (Fail Safe)

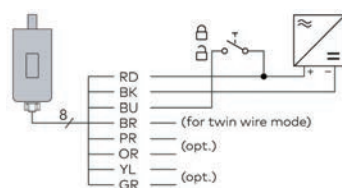

Normal Mode Wiring (Fail Secure)

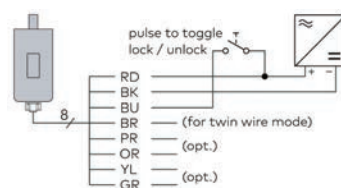

Toggle Mode Wiring

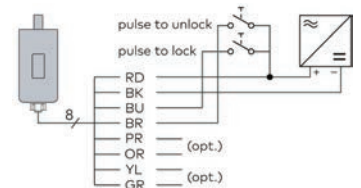

Twin Wire Mode Wiring