



TS 68

The ideal low-cost solution for standard doors

With the TS 68, dormakaba has developed a low-cost door closer which can be universally used on all common door types. It is particularly quick and easy to install – and does not require a mounting backplate.

Plus points

For the trade

- The low cost solution for standard doors.
- Just one model for all mounting positions.

For the installer

- Non-handed unit.
- Quick and easy to install.
- Fixes perfectly to all door types without the need for a mounting backplate.

Certified to ISO 9001

For the architect/specifier

- Compact design.
- Inexpensive, proven reliability.

For the user

- Closing cycle largely unaffected by temperature changes.
- Two valves for optimum closing speed and reliable latching action.

Technical Data		TS 68
Selectable closing force (variable via arm power shoe and templating)		EN 2/3/4
Door width	≤ 1100 mm	●
External doors, outward opening		–
Non-handed		●
Arm	Standard arm	●
	Slide channel	–
Closing speed adjustable via 2 independent valves	180° – 15° 15° – 0°	●
Backcheck		–
Delayed action		–
Hold-open		○
Weight in kg		1.4
Dimensions in mm	Length	220.0
	Overall depth	45.0
	Height	53.5

● Yes – No ○ Option

Standard and optional functions

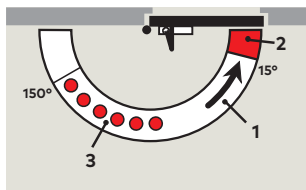

- 1 Adjustable closing speed in the range 180° – 15°.
- 2 Adjustable closing speed in the range 15° – 0°.
- 3 Hold-open range with hold-open arm model (optional extra).

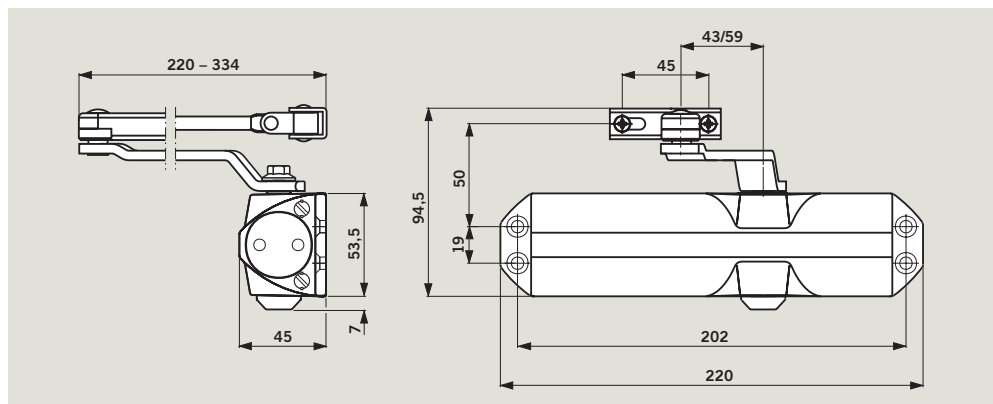

Closing force settings

Door width	Size setting
≤ 850	EN 2
≤ 950	EN 3
≤ 1100	EN 4

The TS 68's size setting is selected for the door width by moving the closer body and/or turning the arm power shoe.

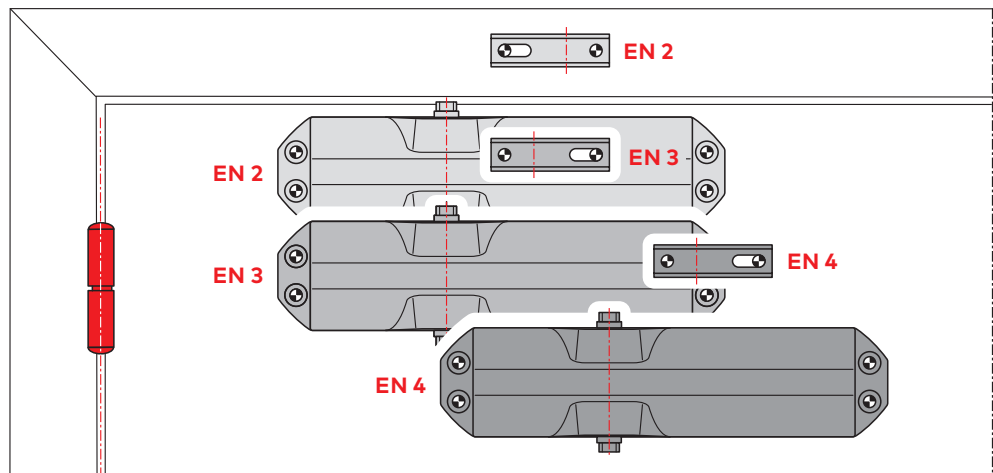

Door-leaf fixing pull side

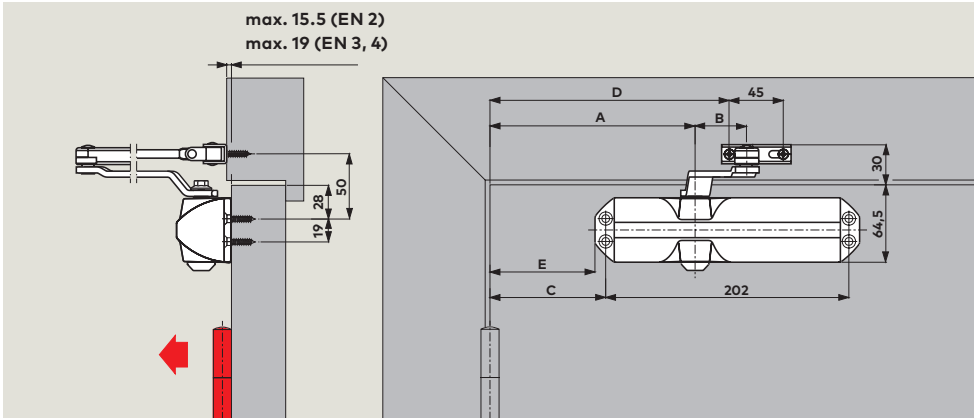

	EN 2	EN 3	EN 4
A	170.0	170.0	250.0
B	59.0	43.0	43.0
C	96.0	96.0	176.0
D	198.5	198.5	278.5
E	87.0	87.0	167.0

Frame fixing, push side

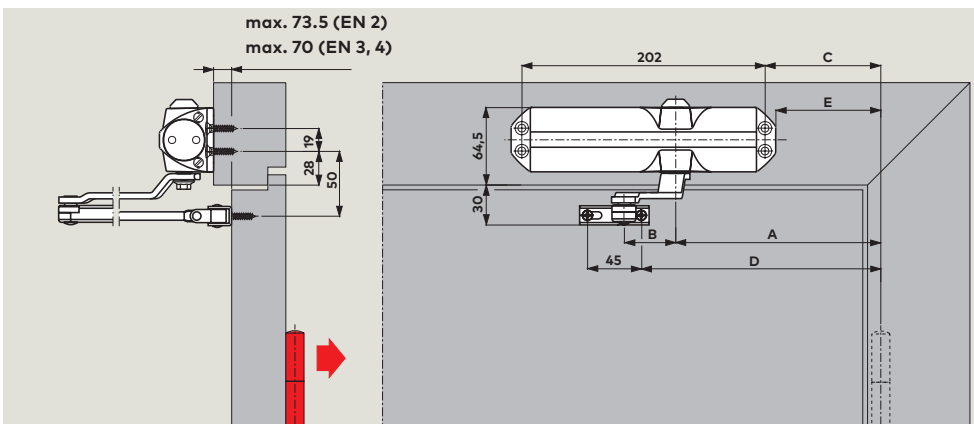

	EN 2	EN 3	EN 4
A	170.0	170.0	250.0
B	59.0	43.0	43.0
C	96.0	96.0	176.0
D	198.5	198.5	278.5
E	87.0	87.0	167.0

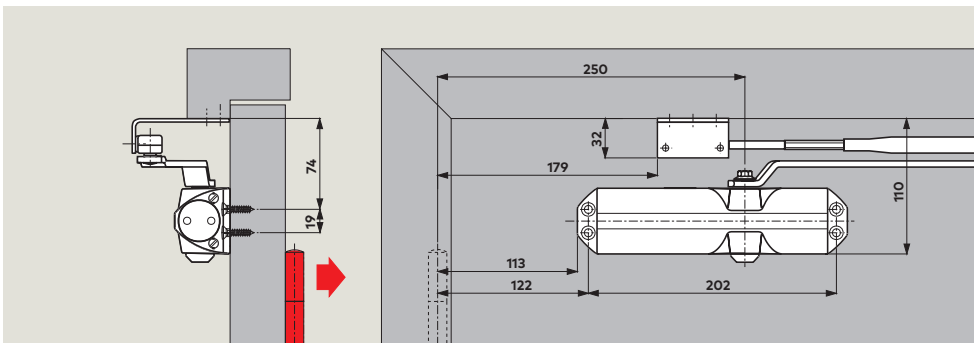

Parallel arm fixing push side



EN 2
(door width max. 850 mm)

Standard equipment and accessories

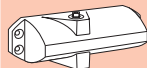
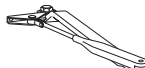
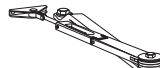
xx	Colour
01	silver
02	brass
03	dark brown
11	white (RAL 9016)

Door closer TS 68	Standard arm	Hold-open arm	Parallel arm bracket
			
Size 2/3/4	■ □ 664001xx	■ □ 664002xx	△ 660005xx

Order-Number
 ■ □ = Closer with arm, complete
 △ = Accessory

Specification text

Rack-and-pinion door closer with selectable closing force, size EN 2, 3 and 4; adjustable closing speed in two independent ranges. Non-handed.

Model
 with standard arm
 with hold-open arm

Colour
 silver
 brass
 white (similar to RAL 9016)

Make
 dormakaba TS 68



www.dormakaba.co.uk

WN 051 579 51532, 08/15, TS 68, GB, x. XXX, xx/15
Subject to change without notice

dormakaba UK & Ireland

E: info.gb@dormakaba.com

Wilbury Way, Hitchin
Hertfordshire
SG4 0AB

T: +44(0)1462 477600
F: +44(0)1462 477601

Lower Moor Way
Tiverton, Devon
EX16 6SS
T: +44(0)870 000 5625
F: +44(0)870 000 5397