

# Argus 40-60-80

# Argus V60

## Sensor barriers

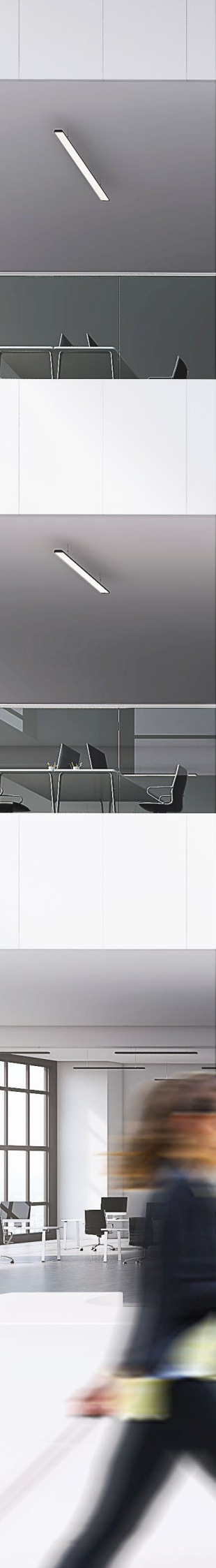





Already today we expect a modern workplace to be more than just a room with a desk, chair and WiFi. And, with an eye to tomorrow, it's clear that we must take the individuality of people and the independence of companies into account architecturally.

What will count in future: an atmosphere in which any movement is possible. The building surpasses itself, overcoming its immobility – for people who are think and move freely. Forwards.

# Openness as a success model.

It's not so long ago since the days when constant presence was a requirement, because the only way to access information was in the office. Today, employees can access information wirelessly and from anywhere. Digitalisation has turned the original foundations upside down and completely redefined presence. Coupled with each employee's desire for individualisation, all architects and investors now face the task of giving presence an entirely new feeling.

To ensure that people see the added value of an office, the space used must tap new

dimensions and promote freedom, flexibility and creativity. Only in this way can a company headquarters also become a company's success factor.

No company can perform as a closed unit or exclusively digitally. To promote something, you have to discuss it with other people, on a human and direct level. And to do this, you need to create the right framework conditions. The following 4 trends show the changes we can expect and how we can deal with them.

## #1 An open working area for many.

Thanks to digitally controllable access systems and flexible room partitioning, freedom and security don't have to be a trade-off. With the right technology, the model of office sharing is becoming increasingly attractive – for all sizes of companies – because sharing multiplies opportunities and knowledge. For example, start-ups with just one desk can use the entire available space and allow their potential to unfold.



TREND

#1  
OPEN SPACE



TREND

#2  
**PAY PER USE**

**#2 Flexible use instead of fixed rental.**

Logically, anyone who doesn't always have to be present in the office, also isn't always using it. With a flexible office structure, free capacities can be marketed in a targeted manner. This kind of intelligent system is based on a convertible interior design and smart access solutions, which guide users along the right path to available and appropriate workplaces.





### #3 Companies in motion.

When three start-up founders quickly turn into 30 employees, a piece of property should not stand in the way of this growth. And the same also applies in the opposite case, such as when there is a need to reduce the size of office units.

With a modular office concept, capacity changes can be managed without friction losses. The feeling conveyed by the property when changes are made is crucial. Does it offer employees room to breathe or does it make them feel lost, because the freed-up workstations make them anxious.

TREND

### #3 CORPORATE SHIFT





TREND

#4  
**HOLISTIC  
HARMONY**

**#4 Aesthetics as lucrative capital.**

All companies, small and large alike, must represent something. The quality of architecture and the design concept are a value worth investing in. The company's identity is already visible and palpable based on the façade of the building or, at the latest, in the foyer. The demand for design is also increasing in terms of the furnishings and technical equipment, as it increases the company's value from the outset – without any risk.

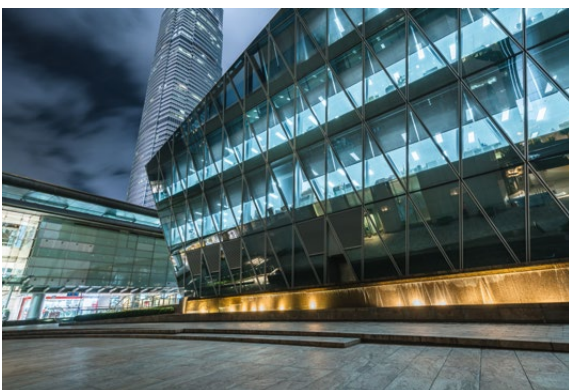



Anyone who is producing access control equipment for the buildings and office worlds of tomorrow needs the right formula. Namely, a formula that consistently combines the customers' needs with the product properties.

» **Freedom decides.**

Argus protects without restricting.

» **An office is a meeting place for ideas.**

Argus guides you accurately.

» **Architecture needs agility.**

Argus moves and adapts.

» **Design follows a clear language.**

Argus always strikes the right note.



Individual customer solution

The shape of the  
perfect function.  
The design.



**Argus sensor barriers define a new elegance: a closed shape for fluid movement. The modules are clearly designed with straight lines and geometrical corner radii. Thus, two slim structures form one symmetrical unit with glass doors that appear weightless.**

The XEA design language, typical of dormakaba, combines basic shapes, colours, surfaces and control elements in a uniform look. In this way, the contemporary monoblock design of Argus makes many variations possible – with seamlessly integrated technology.



Full Cast Layer and Inlay

**Outstanding:  
XEA design language.**

Products communicate with the users. Palpable, audible, visible. The wide-ranging demands need a design line. So, the XEA design is made up of defined basic shapes, functions, colours and surfaces, combined to create aesthetic user-friendliness.

**10 factors count:**

- » Recognisable details.
- » Intuitive symbols.
- » Standardised surfaces.
- » Clear forms.
- » User-friendly operation.
- » Contrasting surfaces.
- » Sturdy coating.
- » Multi-layer compositions.
- » Integrated signal lighting.
- » Personal design.

**Compact, complete, consistent:  
Argus 40**

With a length of just 1,200 mm, Argus 40 is a high-quality sensor barrier that can be used even when space is limited. It impresses with its fine materials and functional basic equipment. It meets normal safety requirements without compromise.

**Argus 60, Argus 80**

Argus 60 at a length of 1,650 mm and Argus 80 at a length of 1,660 mm achieve the maximum security level: The horizontal sensor strip is supplemented with a vertical sensor. In terms of aesthetics, Argus 60 and 80 offer greater freedom of choice, with many material and colour combinations as well as ambient lighting. If you are looking to perfect the finish, choose Argus 80 with Full Cast Layer – a seamlessly wrought hand rail. One design from one piece.



Argus 40

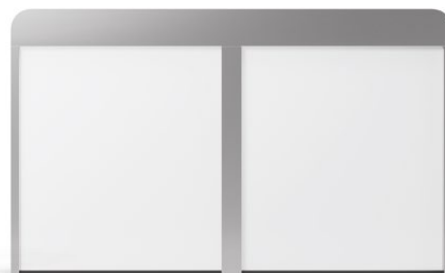

Argus 60  
(with optional side cover)

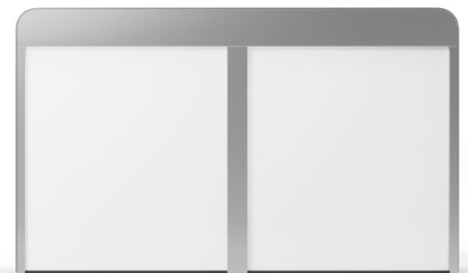

Argus 80



Argus V60  
The Argus V60 offers high safety in a small space.



# Focused on people. The details.

People take centre stage. But with Argus, they don't stop and stand. The door leaves are there to create a barrier, but at the same time they exude transparent openness. The illumination appears friendly, the sensor control works immediately. A movement in noticeable solidity: a friendly welcome.

The modular structure creates freedom. Even when tall doors are required, the person passing through them doesn't perceive them as a forbidding barrier. The design remains subtle, even with maximum stability. The holistic design on the outside demonstrates the inner values: the sensors and mechanical system provide a real service permanently. A polite design.



#### 01 Variable passage width

The barrier-free 915 mm passage for wheelchair users, groups or material transports can be reduced to a standard 650 mm by adjusting the door opening angle, if required.

#### 02 Taller door leaf

For a greater level of security, doors with a 1,800 mm upper edge height can be used. With an optional extended drive column as an additional security barrier.

#### 03 User-optimised scanner integration

The subtly concealed scanner defines the action area with nothing more than an illuminated icon. The prevalent RFID scanner formats can be fitted easily.

#### 04 Discreet ambient lighting

With Argus 60 and 80, the pleasant light design adds a refined finish to the interlock and its surroundings. Optional green or red illuminated elements can be used to indicate operating states.

#### 05 Smart emergency exit and escape route

The system's locking unit can be released in an emergency. The door leaves can be brought to the open position.

#### 06 Secure separation sensors

The sensors in the Argus 40 are positioned efficiently in the leg area. With Argus 60 and 80, an additional, vertical sensor strip is installed, which achieves better recognition of subsequent, unauthorized people and also detects entry from the wrong direction. Likewise, the passage is thus limited to exactly one individual person even for people walking through with suitcases or for wheelchair users.

#### 07 Efficient fixing type

The interlock is secured to the ground with dowels. Alternatively, it can be secured to a pre-installed substructure. When there is underfloor heating, the system can be bonded to the floor with an additional panel.



# Focus on visitor management. The Card Collector.

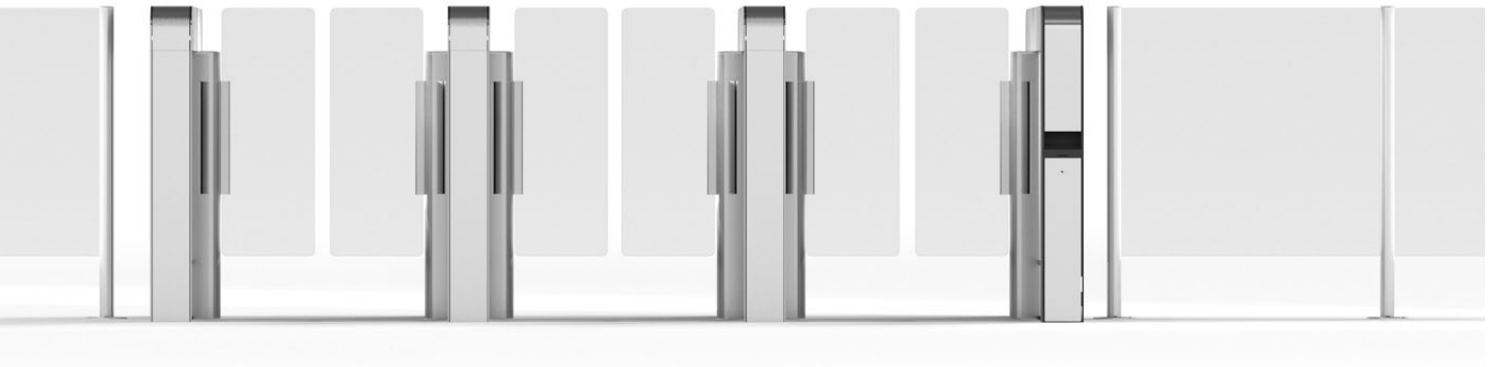

Combining the CRP-M05 Card Collector and Argus enables companies to implement professional visitor management.

The card collector is attached to the Argus 40 or Argus 60 sensor barrier in front of the exit from a secured area. When exiting an access-controlled area, the employee or visitor throws their ID card, together with its protective cover and clip holder, into the illuminated card slot on the column. The visitor badges can be easily removed via the front, lockable flap.

Integrating an on-site RFID system for evaluating access authorisation is also possible.





The CRP-M05 Card Collector is made of anthracite-coloured plastic. The contour is designed in such a way that the column can be attached to the Argus harmoniously and seamlessly for improved functionality and design.



# Variety as the universal design principle. The colours and materials.

All architecture has its challenges. Argus blends in holistically, because the design is modular in structure. This improves the room design as a whole: The interlock becomes an attractive part of the design and more: it becomes a design object in itself. This means it can take a central position with exactly the

right surface, in selected colours. Here, metal is combined with glass and coordinated surfaces, whether with clear or opaque glass, monochrome or with an emphasized contrast between the inlay and the panels on the sides. Argus works in all shades and sets a real highlight.



Glass Clear  
G 800



Glass White  
G 810



Glass Light Grey  
G 830



Glass Black  
G 880

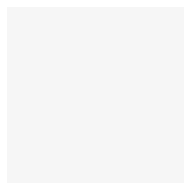

White  
P 100



Cafe Creme  
P 235



Anthracite  
P 180



Black  
P 190



Silver  
N 600



Niro  
N 700



Niro  
S 700

## Matching the Corporate Design.

Every company presents itself in a colour code. Argus interlocks can become an integral part of the look, thanks to their use of accent colours. The interlock is perceived as a design element and not as a technical foreign body. The modularity also exhibits its strengths here: The inlay or Full Cast Layer, together with the side panels in a contrasting colour, jointly accentuate the entire interlock. The combination of functional and corporate colours creates an integrated object.

**One design as if from one piece.**

A scanner can be installed completely seamlessly, behind glass that protects it and leaves no traces of use even after thousands of entries. No construction effort is involved when installing the scanner. The maximum dimensions: 150 mm long, 90 mm wide and 30 mm deep. The typical dormakaba RFID Icon indicates the scanner position subtly and clearly in equal measure.



The protective glass on the reading head is available in white or black. The shade is pre-selected according to the colour selected for the airlock. This can be customised according to the customer's wishes – for example, a preselected black can be changed to white.



»My job as an architect is to plan the future. After all, an office building lives on for more than a century. Like with Argus, a functional and design-oriented focus based on the wishes of future owners and tenants is crucial. A smarter and more creative space for everything that is still to come. That's my vision.«

modular

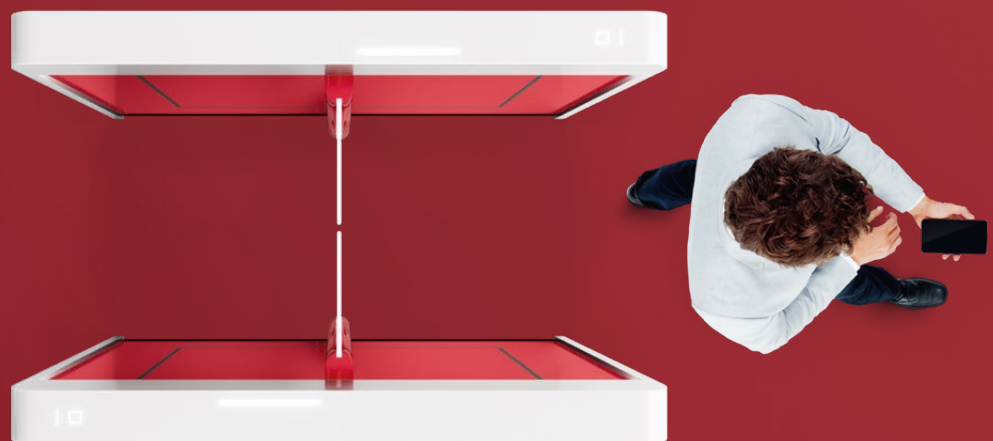

creative

# Adaptation as creative technology. Atmosphere and style.

An Argus sensor barrier creates a striking first impression when you enter a foyer. Together with the reception area, the barriers become a representative part of the building. The facade is the business card, but the sensor barrier delivers a message. The visitors' expectations decide: "How nicely will I be received?"

Argus is there for people and its modularity means it can be adapted to the needs of modern corporate cultures. In every extension version, an elegant object is created, which can be harmoniously combined with every room and its function. It isn't seen as a technical necessity. For the user, Argus is a part of the interior.



Individual customer solution



Individual customer solution



Individual customer solution



»Anyone who, as an entrepreneur, is responsible for a building, must achieve a functioning whole. Modular concepts such as Argus, which adapt to economic requirements and whose function can also be changed again in future, are impressive in this respect.«

modular

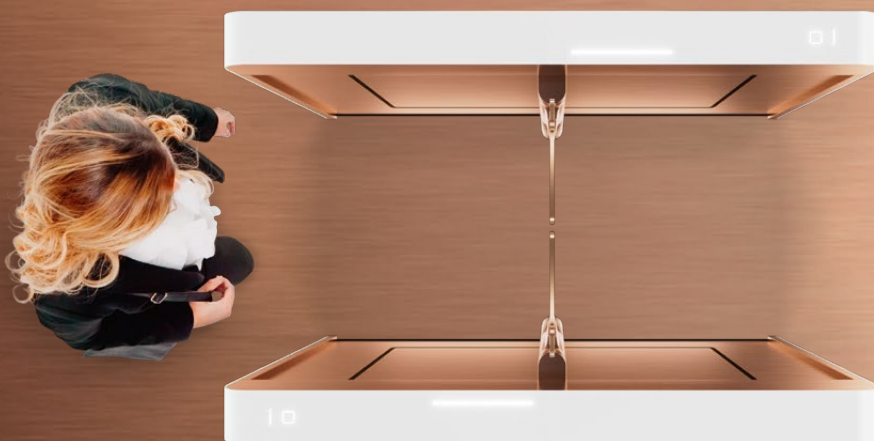

economical



# Achieve all targets. With no obstacles.

The world is diverse. And people are too. And that's exactly what the technology of security interlocks is there for. Argus has a variable design: and is functional also for those with restricted freedom of movement. dormakaba makes no compromises when it comes to user-friendliness. Argus ensures fluid movements, and creates openness and security. Passage widths and opening angles adapt

to requirements, from material transport to complex body movement. The interlock always responds sensitively. It's practically barrier-free. It helps for example wheelchair users. It's the interplay between mechanical elements, digital control and precision sensors that makes Argus the interlock that overcomes all barriers.



## Passage width with variety.

Whether 1,000 mm, 900 mm or 915 mm (36 inches in the USA standard)

- » Extended passage width for every disability.
- » Optimal demand-based opening for material transport.
- » Constant sensor-based monitoring.



Individual customer solution

**Demand-based opening for greater possibilities.**

The extended passage widths for people with a disability, or even for material transports, are monitored by sensors. Consistently functional for security. Depending on the authorisation, the passage width can be varied by reducing the opening angle, e.g. reduced from 900 mm to 650 mm.

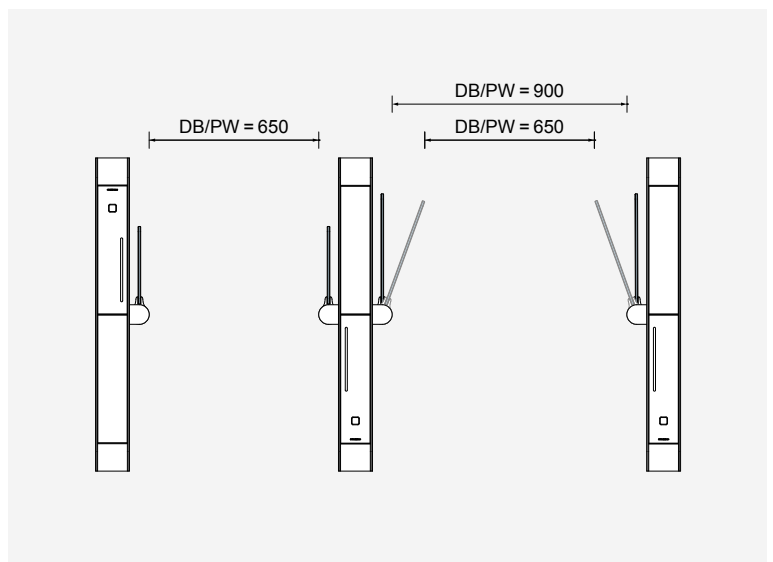

# For particularly large requirements: passage width can be extended to up to 1,600 mm

The extended, non-sensor-monitored passage width can be implemented for access points of up to 1,600 mm - and will visually match the installed Argus sensor barrier. This simplifies access for groups and facilitates the transport of larger goods.

The extended passage width also means that the stipulated escape route widths can be implemented.

The upper edge of the door leaf can be raised to up to 1,800 mm depending on the selected passage width and the door leaf material.

The extended passage width makes it possible to transport larger items.

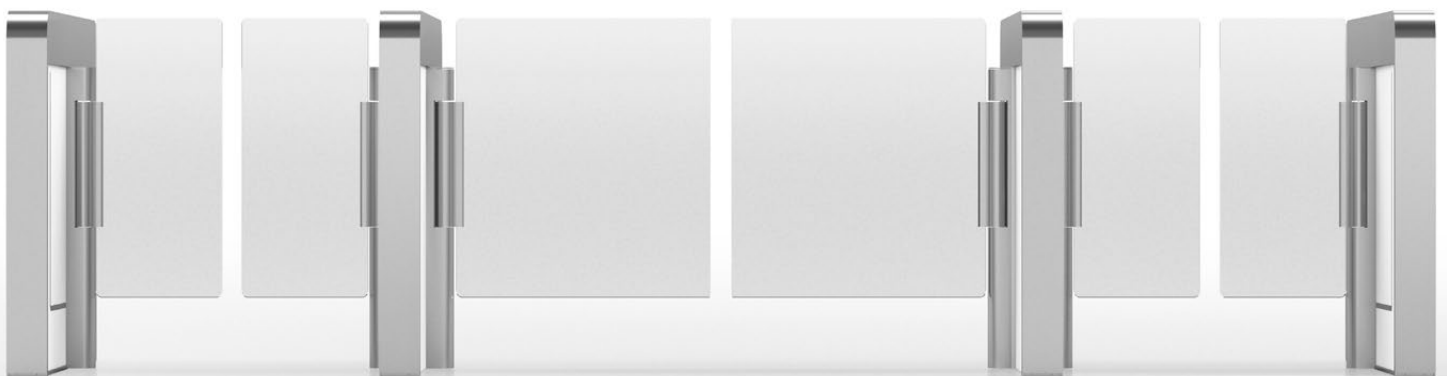



### Opening on demand with the Charon 20 swing door

The Charon swing door can be installed directly on the housing of the Argus sensor barrier. It provides extended passage width with a clear opening of up to 900 mm to accommodate wheelchairs or material trolleys.

The shape, surface and colour of the Charon 20 swing door precisely matches that of the sensor barrier to which it is bolted.

This solution enables a visually appealing and easy-to-implement opening, as electrical components are integrated into the housing of the Argus sensor barrier and the cables are routed through it. No additional cable bores and cable routing are therefore required in the installation area.



### PGB 10 person guiding element

The glass guiding element effectively closes off the dormakaba Argus installations from their surrounding environment. Guiding elements bridge distances to the wall, the lift or the reception area.

The shape and available colours of the aluminium profiles match the design of the Argus series. Widths of between 200 and 1,500 mm and heights from 990 to 1,800 mm can be implemented.

For floor connection, either a screw joint or bonding to a prefab floor are possible, or alternatively, the use of a baseplate for unfinished floors.

# Emergencies pose no problems either. Safety, emergency exits and escape routes.

An intelligent interlock provides security in all directions and in all situations. Things don't always go to plan. But few people want to think about disasters. We, on the other hand, have spent time thinking about all eventualities during the development of Argus. So, in an

emergency, Argus can activate the mechanical system with the help of an optional module. The passage is used as an emergency exit and escape route, tested in accordance with EltVTR as well as EU-standard EN 13637. Open doors for all.

## 01 Smart emergency unlocking

The system's locking device is released via the STV-ETS control unit. The door leaves become freely mobile and can be opened in an emergency or rescue situation. They remain in the open position. When the emergency exit and escape route function is activated, a signal is sent to the building technology.

### Automatic confirmation

The control remains operational during an emergency and can even send a confirmation to a superordinate access control system. An authorised person can switch the system back to normal function using a key-switch.

## 02 Safe Route

The Saferoute Control Unit (SCU) on the system or near the system activates the emergency exit and escape route function, and the key-switch and emergency exit and escape route switches can be integrated. The SCU can also be actuated via the fire alarm system.

## 03 Helpful lighting

With the Argus 60 and 80 models, the integrated lighting can also be used to guide the way in an emergency situation. Ideal when there is thick smoke or in the dark. Beautiful everyday: The technology is elegantly integrated in the design.

## 04 Separation sensors – simple security requirement

In everyday use, the horizontal sensor strip on the Argus 40 ensures that the door leaves move exactly before and after the person passes through and not while they are standing in the sensor area. A person following behind at a distance of more than 300 mm is detected as the next single person. An optional sensor at hip height optimises the separation process.

## 05 Separation sensors – increased security requirement

The L-shaped sensor strip on the Argus 60 and 80 controls optimised opening and closing movements thanks to the additional vertical sensor layout. The system recognises a subsequent, unauthorised person even at a distance of about 100 mm from the person in front. The passage is thus also limited to exactly one individual person for people passing through with suitcases or for wheelchair users. Passage from the wrong direction is also reliably detected.

## 06 Separation sensors – highest/sophisticated safety requirements in short design.

Security level 3. passage area monitored by vertical sensor strips in conjunction with the dormakaba SensLib algorithm. Monitoring of single passage in entry direction (unidirectional). Optionally also in both directions (bidirectional).



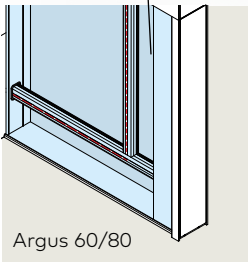

Argus 60/80

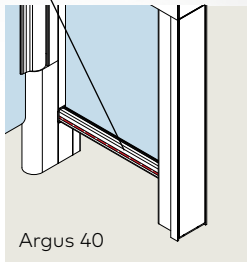

Argus 40

Individual customer solution





»As a building manager, I know that a business plan proves its worth only in reality. Users have to feel comfortable here in the rooms. Design and security shouldn't be a trade-off. Argus meets these requirements. Business rooms become prestigious, secure and functional.«

modular



human



# Argus Components



The **Profile** ensures the entire stability of the system and supports the components.

The **Inlay** covers the technology and shapes the interlock as a closed object.

The **Full Cast Layer** also conceals the profile to produce a seamless monoblock.



The **Door Leaves** convey transparent and frameless lightness.

The **Drive Unit** is integrated as a slim column in the overall system.

The **Panels** close off the frame body flush and set optional colour accents.

# Argus 40

The compact model has everything that an elegant sensor barrier needs. With a length of just 1,200 mm, it is also suitable for installation situations where space is limited. Compared with the longer variants, the equipment is reduced yet offers the full functionality. Panels in the centre of the profile close the open body on request. If you are happy to do without a lighting strip on the hand rail and ambient lighting, you are not missing out on anything with this model. The entire technology is holistically secure. A complete sensor barrier with puristic aesthetics.



Argus 40 Standard Digital Silver  
 Profile/Drive Unit: Silver N 600. Inlay: White P 100  
 Scanner unit: Glass White G 810. Panel: Glass Clear G 800

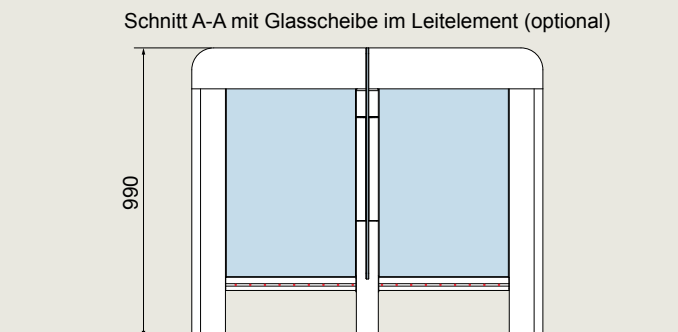
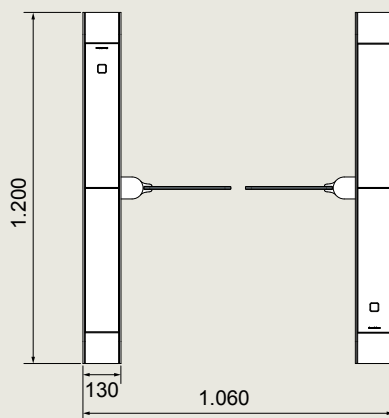
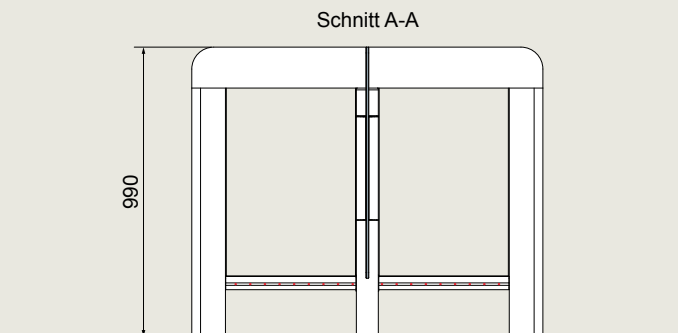
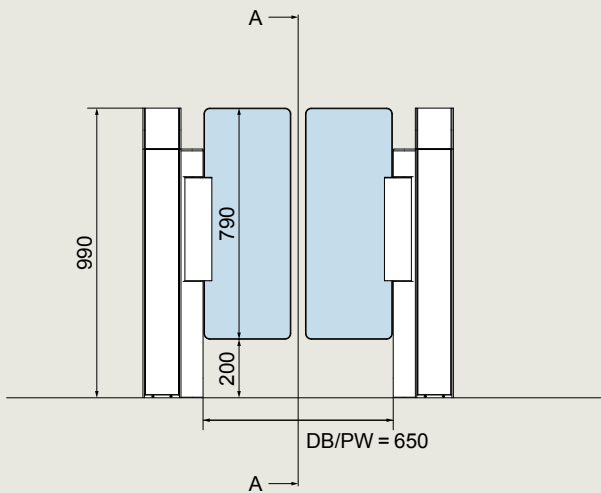

## Basic equipment

## Argus 40

<b>Construction</b>	Interlock height	990 mm
	Interlock length	1,200 mm
	Passage width	650 mm
	Total width	1,060 mm
	Housing, base columns, guiding elements	Profile and inlay elements in the hand rail and in the front of the side panels are made of aluminium
	Blocking elements	Two door leaves made of toughened safety glass, 10 mm, upper edge 990 mm
	Sensors	Sensors in horizontal configuration in leg area
<b>Finish</b>	Surface combinations according to presetting or individual	
<b>Function</b>	Drives	Type 2.* Integrated in the swing tube. Safety level 0. Passage area monitored by simple sensors in the leg area. (Simple monitoring of the single passage in both directions).
	Operation modes	Basic position closed "night-operation": The door leaves open in the direction of passage, once authorised, and then close again
<b>Electric components</b>	Control system and power supply integrated in the unit	
	Power supply	100 - 240 VAC, 50/60 Hz, 300 VA
	Power consumption	18.4 VA**
	Standard adjustment in case of power failure	Door leaves move freely
<b>Installation</b>	Dowelled on finished floor level FFL. Not suitable for outdoor installation!	

\* Type 2: power-assisted motion; two servo-positioning drives/electrically controlled in both directions.

\*\* Standardized cycle with 1,000 passes per day and standby operation in between.

## Options

<b>Version</b>	Single system/Twin system/Triple system/Quadruple system/Multiple system
<b>Sensor-controlled passage width monitored</b>	Passage width 900 mm/915 mm (USA standard for the disabled). Extended passage width with reduced opening angle. Sprocket brake locks when pressed.
<b>Passage width not monitored by sensors</b>	DB = 1,200 mm with maximum top edge 1,800 mm/DB = 1,400 mm with maximum top edge 1,600 mm/ DB = 1,600 mm with maximum top edge 1,200 mm
<b>Door leaf increase with Drive unit 850 mm</b>	Upper edge of door leaf: 1,200 mm/1,400 mm/1,600 mm/1,800 mm
<b>Drive unit increases to same upper edge as door leaf</b>	Upper edge of door leaf: 1,200 mm/1,400 mm/1,600 mm/1,800 mm
<b>Scanner installation</b>	Flush-mounted socket in the hand rail for on-site installation/Universal, concealed scanner installation behind ESG 6 mm with RFID symbol L/W/H 150x90x30 mm/Preparation for a surface-mounted scanner attachment in the vertical surface, e.g. for wheelchair users (height 850 mm)
<b>User guidance</b>	Illuminated RFID icon in white, red and green
<b>Use in emergency exits and escape routes</b>	The SafeRoute Control Unit (SCU) on or near the system activates the escape and rescue route function.
<b>Mean cycles between failures (MCBF)</b>	DB = 650 mm: 10 Mio., DB = 900 mm: 8 Mio.
<b>Separation sensors</b>	Separation sensor in hip area (Security Level 1.5)
<b>Product declaration</b>	Environmental Product Declaration: EPD-DOR-20200033-IBA1-EN Health Product Declaration: standard procedure MEMBER

# Argus 60

The 1,650 mm long version of the sensor barrier offers more options than the Argus 40: Functionally, the security level is increased, as a vertical strip is installed as an add-on sensor in addition to the horizontal safety sensor strip. The height of the door leaves can be increased compared with the standard version. The light strip in the hand rail ensures pleasant orientation. Ambient lighting is integrated to improve aesthetics – the interlock becomes a real highlight in the foyer. The sides are each provided with two panels so that the entire system has the look of a monoblock design. This is contrasted with the highly transparent door leaves. Security with ease.



Argus 60 customer solution  
 Profile/Drive Unit: Cafe Creme P 235. Inlay: Niro N 700  
 Scanner unit: Glass Black G 880. Panel: Glass White G 810

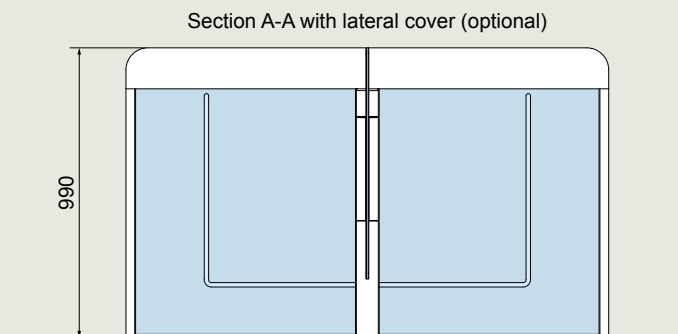
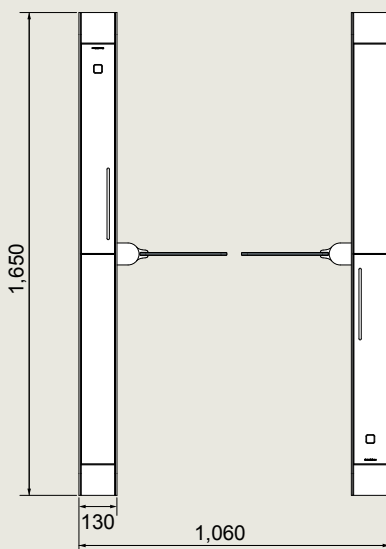
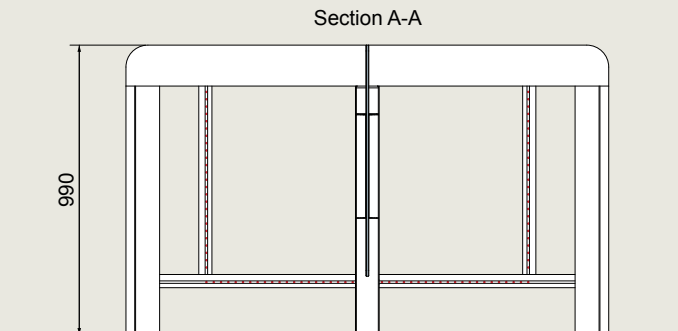
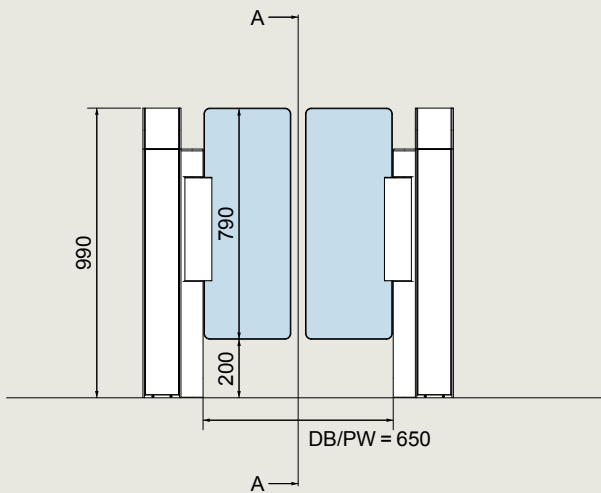

## Basic equipment

## Argus 60

<b>Construction</b>	Interlock height	990 mm
	Interlock length	1,650 mm
	Passage width	650 mm
	Total width	1,060 mm
	Housing, base columns, guiding elements	Profile and inlay elements in the hand rail and in the front of the side panels are made of aluminium
	Blocking elements	Two door leaves made of toughened safety glass, 10 mm, upper edge 990 mm
	Sensors	The sensor system is integrated in the guiding elements both horizontally and vertically
<b>Finish</b>	Surface combinations according to presetting or individual	
<b>Function</b>	Drives	Type 2.* Integrated in the swing tube. Safety level 2. Passage area monitored by enhanced sensor system with an optimised installation length and arrangement (increased level of single passage monitoring in both directions, including detection of opposite direction).
	Operation modes	Basic position closed "night-operation": The door leaves open in the direction of passage, once authorised, and then close again
<b>Electric components</b>	Control system and power supply integrated in the unit	
	Power supply	100 - 240 VAC, 50/60 Hz, 300 VA
	Power consumption	18.4 VA (58 VA with ambient lighting)**
	Standard adjustment in case of power failure	Door leaves move freely
<b>Installation</b>	Dowelled on finished floor level FFL. Not suitable for outdoor installation!	

\* Type 2: power-assisted motion; two servo-positioning drives/electrically controlled in both directions.

\*\* Standardized cycle with 1,000 passes per day and standby operation in between.

## Options

<b>Version</b>	Single system/Twin system/Triple system/Quadruple system/Multiple system
<b>Sensor-controlled passage width monitored</b>	Passage width 900 mm/915 mm (USA standard for the disabled)/1,000 mm. Extended passage width with reduced opening angle. Sprocket brake locks when pressed.
<b>Passage width not monitored by sensors</b>	DB = 1,200 mm with maximum top edge 1,800 mm/DB = 1,400 mm with maximum top edge 1,600 mm/DB = 1,600 mm with maximum top edge 1,200 mm
<b>Door leaf increase with Drive unit 850 mm</b>	Upper edge of door leaf: 1,200 mm/1,400 mm/1,600 mm/1,800 mm
<b>Drive unit increases to same upper edge as door leaf</b>	Upper edge of door leaf: 1,200 mm/1,400 mm/1,600 mm/1,800 mm
<b>Scanner installation</b>	Flush-mounted socket in the hand rail for on-site installation/Universal, concealed scanner installation behind ESG 6 mm with RFID symbol L/W/H 150x90x30 mm/Preparation for a surface-mounted scanner attachment in the vertical surface, e.g. for wheelchair users (height 850 mm)
<b>User guidance</b>	Illuminated RFID icon in white, red and green/White-red-green running light integrated in the hand rail
<b>Ambient lighting:</b>	In the passage area LED white K4000/On the outside LED white K4000/ Additional red and green for status display
<b>Mean cycles between failures (MCBF)</b>	DB = 650 mm: 10 Mio., DB = 900 mm: 8 Mio.
<b>Use in emergency exits and escape routes</b>	The SafeRoute Control Unit (SCU) on or near the system activates the escape and rescue route function.
<b>Product declaration</b>	Environmental Product Declaration: EPD-DOR-20200033-IBA1-EN Health Product Declaration: standard procedure MEMBER

# Argus V60

## Particularly compact, strikingly elegant

Despite a housing depth of only 240 mm, the Argus V60 is a full-performance sensor barrier ideal for use where space is limited. The reader units can be installed the same way as other versions of the Argus product range.



Argus V60 customer solution  
 Profile/Drive Unit/Inlay: White P 100.  
 Scanner unit: Glass White G 810. Panel: Glass Clear G 800

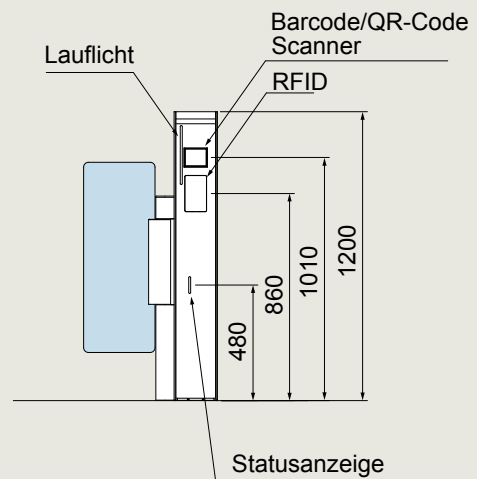
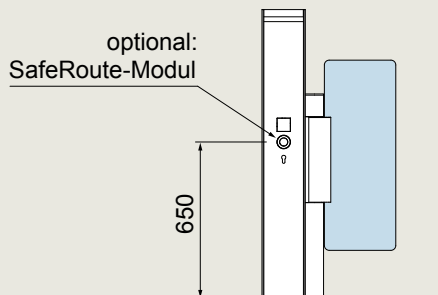
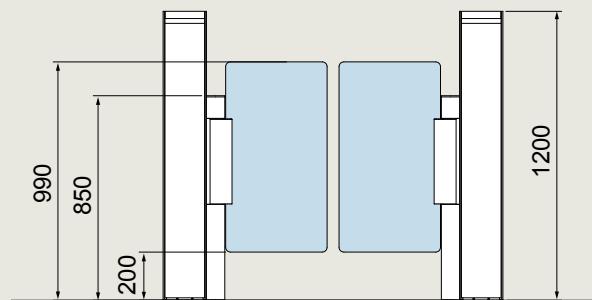
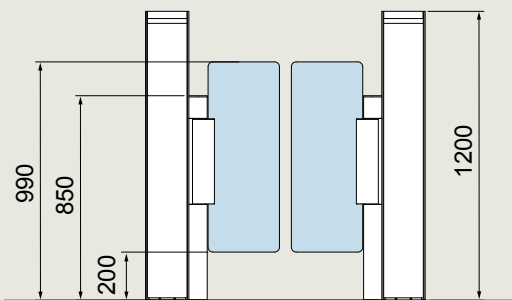

## Standard systems

## Argus V60

<b>Structure</b>	Lock height	1,200 mm
	Lock length	240 mm
	Passage width	650 mm
	Total width	1,161 mm
	Housing, inlays, drive cover and tube	The housing, the inlays in the front and rear, as well as the drive cover and drive tube are made of aluminium sections.
	Barrier elements	Two door leaves of toughened safety glass 10 mm, upper edge 990 mm.
	Sensor system	Passage area monitored by vertical security sensors. Additional sensor monitoring of the swing area of the barrier elements as a safety feature.
<b>Visible surfaces</b>	All aluminium profiles powder coated in white P100 (True White Preset).	
<b>Function</b>	Drives and control system	Type 2.* Built into the swivel tube. Security level 3, optionally up to 3.1. Passage area monitored by vertical sensor strips in conjunction with the dormakaba SensLib algorithm. Monitoring of single passage in entry direction (unidirectional security level 3.). Optionally also in both directions (bidirectional security level 3.1).
	Operating modes	Closed basic state "Night-time mode": The door leaves open upon authorisation in the passage direction and close again afterwards.
<b>Electronics</b>		Control and power supply units integrated into the system.
	Power supply	100–240 VAC 50/60 Hz, 300 VA
	Standby power	18.4 VA**
	Standard setting in the event of a power failure	Door leaves swing without resistance
<b>Installation</b>	Dowelled on finished floor (FFB). Not suitable for installation outdoors!	

\* Type 2: Movement motorised; two servo position drives/two directions electrically controlled

\*\* Standardised cycle with 1,000 passages per day and standby mode in between.

## Optional extras

<b>Version</b>	Single/dual/triple/four/multiple-lane system
<b>Sensor-controlled passage width monitored</b>	Passage width 900 mm/915 mm (USA standard for the disabled)/1,000 mm. Extended passage width with reduced opening angle. Sprocket brake locks when pressed.
<b>Door leaf raised</b>	Door leaf upper edge: 1,200 mm
<b>Reader installation</b>	Universal, concealed reader installation behind toughened safety glass 6 mm with RFID symbol L/W/H 150 x 90 x 30 mm/Preparation for installation of a barcode reader type Access ATR 200.
<b>Visible surfaces</b>	Deep Black / Organic Sand / Collection Colours
<b>User guidance</b>	Illuminated RFID icon in white, red and green/white-red-green running light, installed on both sides in the vertical inlays.
<b>Mean cycles between failures (MCBF)</b>	Passage width=650 mm: 10 million, passage width=900 mm: 8 million
<b>Use in escape routes and emergency exits</b>	The SafeRoute Control Unit (SCU) in or near the system activates the escape route and emergency exit function.
<b>Bidirectional security separation</b>	Monitoring of the individual passage both in entry and exit direction.



# Argus 80

A consistently high-quality design: The interlock has a particularly solid and refined look, as the upper section, with the front and rear vertical frame sections, is worked seamlessly in one piece – as a Full Cast Layer. The shimmering metal has the look of an “endless” hand rail. The Full Cast Layer makes the interlock just one centimetre longer. The equipment is just as varied as in the Argus 60 in terms of the security modules, the colour combinations, the running light, the ambient lighting and the door heights. Customisation is also possible: The side panels can also be produced in corporate colours.



Argus 80 customer solution  
 Profile: Niro N700. Drive Unit: Light Grey P 130  
 Full Cast Layer: anodized black. Scanner unit: Glass Black G 880  
 Panel: Glass Light Grey G 830

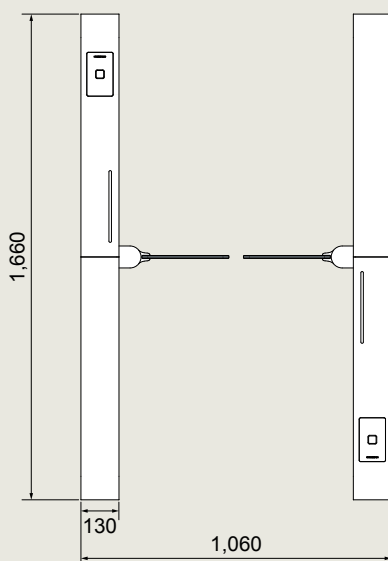
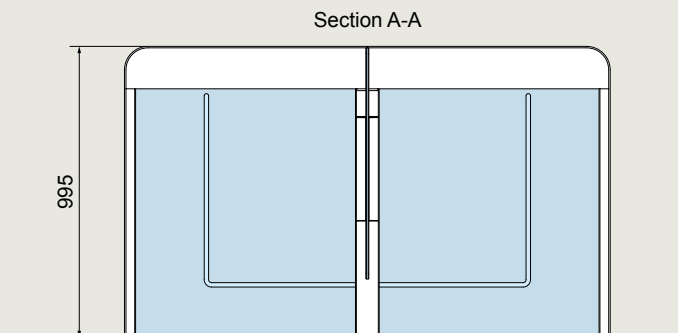
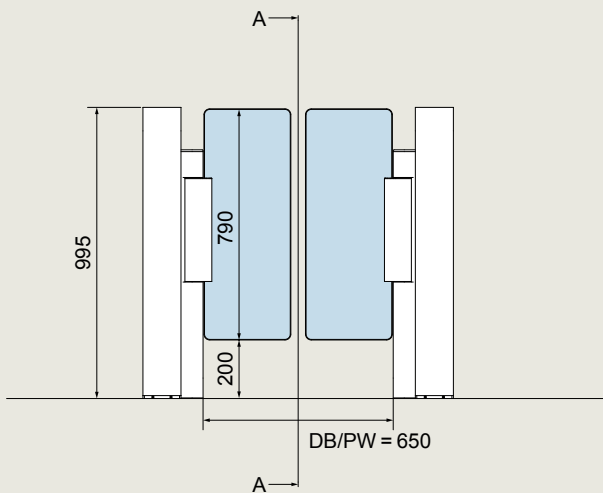

## Basic equipment

## Argus 80

<b>Construction</b>	Interlock height	995 mm
	Interlock length	1,660 mm
	Passage width	650 mm
	Total width	1,060 mm
	Housing, base columns, guiding elements	Profile with all-round cover in the hand rail and the front made of aluminium in the side section. Side covering of the sensors by printed discs in the respective colour tone defined in the presettings
	Blocking elements	Two door leaves made of toughened safety glass, 10 mm, upper edge 990 mm
	Sensors	The sensor system is integrated in the guiding elements both horizontally and vertically
<b>Finish</b>	Surface combinations according to presetting or individual	
<b>Function</b>	Drives	Type 2.* Integrated in the swing tube. Safety level 2. Passage area monitored by enhanced sensor system with an optimised installation length and arrangement (increased level of single passage monitoring in both directions, including detection of opposite direction).
	Operation modes	Basic position closed "night-operation": The door leaves open in the direction of passage, once authorised, and then close again
<b>Electric components</b>	Control system and power supply integrated in the unit	
	Power supply	100 - 240 VAC, 50/60 Hz, 300 VA
	Power consumption	18.4 VA (58 VA with ambient lighting)**
	Standard adjustment in case of power failure	Door leaves move freely
<b>Installation</b>	Dowelled on finished floor level FFL. Not suitable for outdoor installation!	

\* Type 2: power-assisted motion; two servo-positioning drives/electrically controlled in both directions.

\*\* Standardized cycle with 1,000 passes per day and standby operation in between.

## Options

<b>Version</b>	Single system/Twin system/Triple system/Quadruple system/Multiple system
<b>Sensor-controlled passage width monitored</b>	Passage width 900 mm/915 mm (USA standard for the disabled)/1,000 mm. Extended passage width with reduced opening angle. Sprocket brake locks when pressed.
<b>Passage width not monitored by sensors</b>	DB = 1,200 mm with maximum top edge 1,800 mm/DB = 1,400 mm with maximum top edge 1,600 mm/DB = 1,600 mm with maximum top edge 1,200 mm
<b>Door leaf increase with Drive unit 850 mm</b>	Upper edge of door leaf: 1,200 mm/1,400 mm/1,600 mm/1,800 mm
<b>Drive unit increases to same upper edge as door leaf</b>	Upper edge of door leaf: 1,200 mm/1,400 mm/1,600 mm/1,800 mm
<b>Scanner installation</b>	Flush-mounted socket in the hand rail for on-site installation/Universal, concealed scanner installation behind ESG 6 mm with RFID symbol L/W/H 150x90x30 mm/Preparation for a surface-mounted scanner attachment in the vertical surface, e.g. for wheelchair users (height 850 mm)
<b>User guidance</b>	Illuminated RFID icon in white, red and green/White-red-green running light integrated in the hand rail
<b>Ambient lighting:</b>	In the passage area LED white K4000/On the outside LED white K4000/ Additional red and green for status display
<b>Mean cycles between failures (MCBF)</b>	DB = 650 mm: 10 Mio., DB = 900 mm: 8 Mio.
<b>Use in emergency exits and escape routes</b>	The SafeRoute Control Unit (SCU) on or near the system activates the escape and rescue route function.
<b>Product declaration</b>	Environmental Product Declaration: EPD-DOR-20200033-IBA1-EN Health Product Declaration: standard procedure MEMBER



»For me as a system integrator, security builds on many modules. User acceptance must be harmonised with various types of access authorisation and data evaluation. Argus offers a modular structure for all eventualities.«

modular

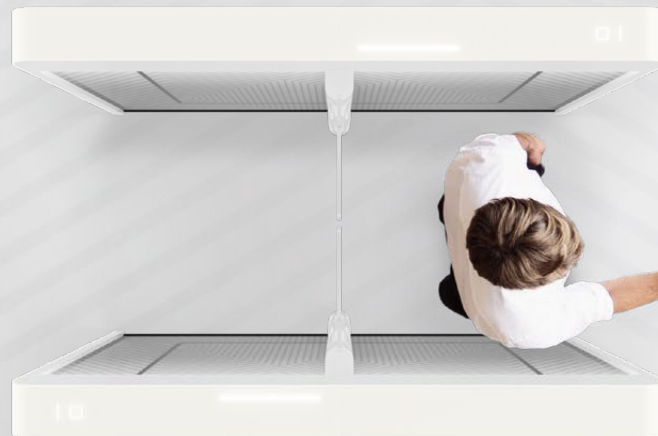

integrable

# Argus Color Index

## Profile Argus 40/60/80



White P 100   Cafe Creme P 235   Anthracite P 180   Black P 190   Silver N 600   Niro N 700

## Drive Unit Argus 40/60/80



White P 100   Cafe Creme P 235   Anthracite P 180   Black P 190   Silver N 600   Niro N 700

## Inlay Argus 40/60. Full Cast Layer Argus 80.



White P 100   Anthracite P 180   Silver N 600   Niro N 700   Niro S 700 (only Argus 40/60)

## Swing Door Argus 40/60/80



Glass Clear G 800   polycarbonate\* Clear G 801

\* Optionale Ausführung

## Panel Argus 40



Glass Clear G 800

## Panel Argus 60/80



Glass Clear G 800   Glass White G 810   Glass Light Grey G 830   Glass Black G 880   Niro S 700

## Custom Argus 40/60/80

Individual RAL, Individual Inlay Material, Individual Door Print.

Argus 40 uses a clear pane in the centre of the guiding element instead of a side cover. This always uses the material Glass Clear G 800.

All pre-configured surface combinations can be freely selected using the Collection option.

# Argus configuration Standard and Collection

Nice and simple. The classical colour combinations are timeless and fit into any architecture.

## Standard

Our standard pre-settings offer design-coordinated colour combinations for many different types of settings

## Collection

For greater individuality, use the Collection configuration option to combine your desired colours from the Argus Color Index (see page 42).



## Argus Pre-Setting **Digital Silver**

<b>Profile</b>	Silver N 600
<b>Drive Unit</b>	Silver N 600
<b>Inlay</b>	Argus 40/60: Silver N 600. Optional: White P 100.
<b>Full Cast Layer</b>	Argus 80: Silver N 600. Optional: White P 100.
<b>Scanner unit</b>	Glass White G 810. Optional: Glass Black G 880
<b>Swing Door*</b>	Glass Clear G 800 Optional: Polycarbonat Clear G 801
<b>Panel</b>	Argus 40: optional Glass Clear G 800
	Argus 60: optional Glass Clear G 800
	Argus 80: Glass Clear G 800

Image: Argus 40 Pre-Setting Digital Silver  
Profile/Drive Unit/Inlay: Silver N 600  
Scanner unit: Glass White G 810. Panel: Glass Clear G 800

## Argus Pre-Setting **Corporate Satin**

<b>Profile</b>	Niro N 700
<b>Drive Unit</b>	Niro N 700
<b>Inlay</b>	Argus 40/60: Niro N 700. Optional: White P 100.
<b>Full Cast Layer</b>	Argus 80: Niro N 700. Optional: White P 100.
<b>Scanner unit</b>	Glass Black G 880. Optional: Glass White G 810
<b>Swing Door*</b>	Glass Clear G 800 Optional: Polycarbonat Clear G 801
<b>Panel</b>	Argus 40: optional Glass Clear G 800
	Argus 60: optional Glass White G 810
	Argus 80: Glass White G 810

Image: Argus 80 Pre-Setting Corporate Satin  
Profile/Drive Unit: Niro N 700. Full Cast Layer: White P 100  
Scanner unit: Glass White G 810. Panel: Glass White G 810

\*Depending on the upper edge of the door leaf and the length of the swing tube.

# Argus configuration Standard and Collection

Contrasts create atmosphere. After all, the reception area is the first impression of the interior of the office building. The Collection configuration allows you to choose from finely graduated combinations of metal and glass.



## Argus Pre-Setting **True White**

<b>Profile</b>	White P 100
<b>Drive Unit</b>	White P 100
<b>Inlay</b>	Argus 40/60: White P 100
<b>Full Cast Layer</b>	Argus 80: White P 100
<b>Scanner unit</b>	Glass White G 810. Optional: Glass Black G 880
<b>Swing Door*</b>	Glass Clear G 800 Optional: Polycarbonat Clear G 801
<b>Panel</b>	Argus 40: optional Glass Clear G 800
	Argus 60: optional Glass Light Grey G 830
	Argus 80: Glass Light Grey G 830

## Argus Pre-Setting **Deep Black**

<b>Profile</b>	Black P 190
<b>Drive Unit</b>	Black P 190
<b>Inlay</b>	Argus 40/60: Silver N 600
<b>Full Cast Layer</b>	Argus 80: Silver N 600
<b>Scanner unit</b>	Glass White G 810. Optional: Glass Black G 880
<b>Swing Door*</b>	Glass Clear G 800 Optional: Polycarbonat Clear G 801
<b>Panel</b>	Argus 40: optional Glass Clear G 800
	Argus 60: optional Glass Black G 880
	Argus 80: Glass Black G 880

Image: Argus 80 Pre-Setting True White  
Profile/Drive Unit/Full Cast Layer: White P 100  
Scanner unit: Glass White G 810. Panel: Glass Light Grey G 830

Image: Argus 60 Pre-Setting Deep Black  
Profile/Drive Unit: Black P 190. Inlay: Silver N 600  
Scanner unit: Glass White G 810. Panel: Glass Black G 880.

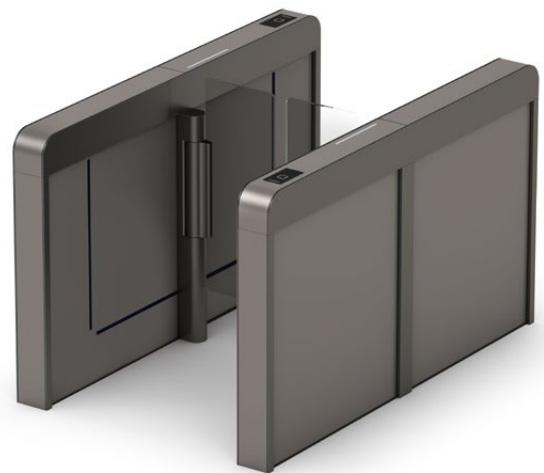
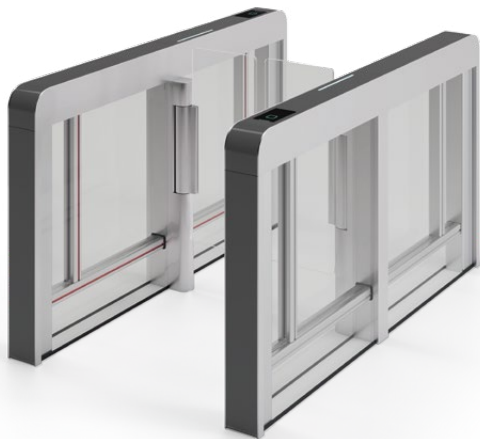

### Argus Pre-Setting **Vector Edge**

<b>Profile</b>	Silver N 600
<b>Drive Unit</b>	Silver N 600
<b>Inlay</b>	Argus 40/60: Anthracite P 180
<b>Full Cast Layer</b>	Argus 80: Anthracite P 180
<b>Scanner unit</b>	Glass Black G 880. Optional: Glass White G 810
<b>Swing Door*</b>	Glass Clear G 800 Optional: Polycarbonat Clear G 801
<b>Panel</b>	Argus 40: optional Glass Clear G 800
	Argus 60: optional Glass Clear G 800
	Argus 80: Glass Clear G 800

Image: Argus 60 Pre-Setting Vector Edge  
 Profile/Drive Unit: Silver N 600. Inlay: Anthracite P 180  
 Scanner unit: Glass Black G 880. Panel: Glass Clear G 800

### Argus Pre-Setting **Core Steel** (only Argus 40 and 60)

<b>Profile</b>	Anthracite P 180
<b>Drive Unit</b>	Anthracite P 180
<b>Inlay</b>	Argus 40/60: Niro S 700
<b>Scanner unit</b>	Glass Black G 880. Optional: Glass White G 810
<b>Swing Door*</b>	Glass Clear G 800 Optional: Polycarbonat Clear G 801
<b>Panel</b>	Argus 40: optional Glass Clear G 800
	Argus 60: optional Niro S 700

Image: Argus 60 Pre-Setting Core Steel  
 Profile/Drive Unit: Anthracite P 180.  
 Scanner unit: Glass Black G 880. Panel: Niro S 700.

\*Depending on the upper edge of the door leaf and the length of the swing tube.



# Argus configuration Standard and Collection

Contemporary interior design has rediscovered warm, natural colour tones. As an alternative to widespread grey, technical systems, Argus, in Cafe-Creme shades, can become a subtle unit that blends into its surroundings.



## Argus Pre-Setting **Organic Sand**

<b>Profile</b>	Cafe Creme P 235
<b>Drive Unit</b>	Cafe Creme P 235
<b>Inlay</b>	Argus 40/60: Anthracite P 180
<b>Full Cast Layer</b>	Argus 80: Anthracite P 180
<b>Scanner unit</b>	Glass Black G 880. Optional: Glass White G 810
<b>Swing Door*</b>	Glass Clear G 800 Optional: Polycarbonat Clear G 801
<b>Panel</b>	Argus 40: optional Glass Clear G 800
	Argus 60: optional Glass White G 810
	Argus 80: Glass White G 810

## Argus Pre-Setting **True White**

<b>Profile</b>	White P 100
<b>Drive Unit</b>	White P 100
<b>Inlay</b>	White P 100
<b>Scanner unit</b>	Glass White G 810 Optional: Glass White G 810
<b>Swing Door*</b>	Glass Clear G 800 Optional: Polycarbonat Clear G 801

Image: Argus 60 Pre-Setting Organic Sand  
Profile/Drive Unit: Cafe Creme P 235. Inlay: Anthracite P 180  
Scanner unit: Glass Black G 880. Panel: Glass White G 810



### Argus Pre-Setting **Organic Sand**

<b>Profile</b>	Cafe Creme P 235
<b>Drive Unit</b>	Cafe Creme P 235
<b>Inlay</b>	Anthracite P 180
<b>Scanner unit</b>	Glass Black G 880. Optional: Glass White G 810
<b>Swing Door*</b>	Glass Clear G 800 Optional: Polycarbonat Clear G 801

### Argus Pre-Setting **Deep Black**

<b>Profile</b>	Black P 190
<b>Drive Unit</b>	Black P 190
<b>Inlay</b>	Silver N 600
<b>Scanner unit</b>	Glass White G 810 Optional: Glass Black G 880
<b>Swing Door*</b>	Glass Clear G 800 Optional: Polycarbonat Clear G 801

Image: Argus 60 Pre-Setting Organic Sand  
 Profile/Drive Unit: Cafe Creme P 235. Inlay: Anthracite P 180  
 Scanner unit: Glass Black G 880. Panel: Glass White G 810

\*Depending on the upper edge of the door leaf and the length of the swing tube.

# Argus Konfiguration Custom

Each company is unique. The design of the Argus sensor barriers can reflect this uniqueness. The panels and even the door leaves can easily be modified to suit a particular colour or finish. Transparent or opaque, with a striking company logo or coloured ambient lighting, to make the right impression on entering.





Door  
Hardware



Electronic  
Access & Data



Mechanical  
Key Systems



Lodging  
Systems



Entrance  
Systems



Interior Glass  
Systems



Safe  
Locks



Service

WN 05501451532, 10/22, EN  
Subject to change without notice



[dormakaba.dk](https://dormakaba.dk)



[dormakaba.no](https://dormakaba.no)



[dormakaba.fi](https://dormakaba.fi)



[dormakaba.se](https://dormakaba.se)

**dormakaba Danmark A/S**  
T: 44 54 30 00  
[info.dk@dormakaba.com](mailto:info.dk@dormakaba.com)  
[www.dormakaba.dk](https://www.dormakaba.dk)

**dormakaba Norge AS**  
Tlf: 06866  
[firmapost.no@dormakaba.com](mailto:firmapost.no@dormakaba.com)  
[www.dormakaba.no](https://www.dormakaba.no)

**dormakaba Suomi Oy**  
P: 010-218 81 00  
[info.fi@dormakaba.com](mailto:info.fi@dormakaba.com)  
[www.dormakaba.fi](https://www.dormakaba.fi)

**dormakaba Sverige AB**  
T: +46 31 355 20 00  
[info.se@dormakaba.com](mailto:info.se@dormakaba.com)  
[www.dormakaba.com](https://www.dormakaba.com)