

Solitaire

850L/850/950

Electronic Access Control Systems

Specification Sheet

Access with a magnetic stripe card



Dimensions

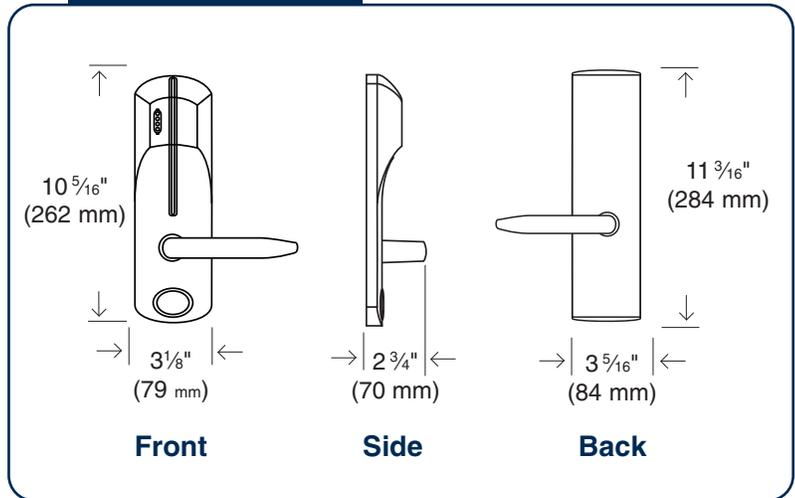

Application

Solitaire locks quickly replace any traditional key operated door lock to provide access with a magnetic stripe card. Each user carries one personalized card (ID card, keycard or bank card) for access to all rooms they are authorized to enter. The Solitaire series offers a choice of concepts that fit any size of facility, from just a few doors to thousands of doors in a large office, factory, lab, educational campus or public institution.

Features

- Replaces your current door lock
- Battery powered, with no wiring required
- Automatically locks or unlocks on a schedule
- Keeps an audit record in memory each time access is granted
- Each user needs just one keycard for all their access needs
- Adapts to any size of facility, from just a few doors to thousands of doors
- Uses economical magnetic stripe cards
- Off-the-shelf AA batteries last 4 to 5 years or 100,000 openings
- Heavy duty construction and extra-durable finish
- ANSI Grade 1 certification



Tel.: 1-800-849-8324
www.kaba-ilco.com

System Specifications

Construction: Heavy-duty cylindrical or mortise lock; cast front housing and brass trim plate; cast levers

Card: Operates with magnetic cards (like bank cards)

Operating Conditions: -31°F to 151°F (-35°C to 66°C)

Batteries: 4 x AA alkaline

Lock Operation:

- **Audit:** Solitaire 850 and 850L last 1000 transactions, Solitaire 950 last 800 transactions
- **Time Zones:** 14 programmable zones per door
- **Vacations & Holidays:** 18 per door
- **Passage Mode:** Accessible by card, thumbturn or lock programming

Key Override: Removable core cylinder (accepts major brands) or conventional key-in-lever cylinder

Certification:

- **Cylinder Drive Lock:** Conforms to ANSI/BHMA A156.25

- **Mortise Lock:** ANSI/BHMA 15.13 grade 1

- **ADA compliant**

- **Three-hour U.L./U.L.C. Fire Door rating**

Strike: Included

Latch: 1/2" (13 mm)

Backset: 2 3/4" (70 mm)

Door Thickness: 1 3/8" (35 mm) to 2 1/2" (66 mm)

Installation:

- **Cylindrical Drive Lock:** ASA 161 door preparation with additional through bore holes

- **Mortise Lock:** Standard mortise preparation

Door Handing: Factory set

Standard Finish: 626 Satin Chrome

Optional Finishes: 605 Bright Brass, 625 Bright Chrome, 612 Satin Bronze, 622 Black Painted, and 606 Satin Brass

Three Kinds of Security:

Choose the software that matches the current needs of your facility, and upgrade anytime:

The LearnLok System Solitaire 850L

Ideal for up to 25 users (Maximum 200) and less than 10 doors.

This system requires no computer. The lock "learns" to recognize each user's card when you swipe a "learn" card through the lock, followed by the user's card.



Model 85150 Vers. L

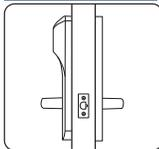

- Cylindrical Drive Lock
- Passage mode activated with card

Model 85010 Vers. L

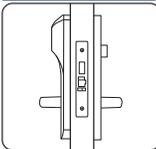

- Mortise Lock
- Passage mode activated with card
- 1" Deadbolt

Model 85112 Vers. L

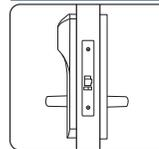

- Mortise Lock
- Passage mode activated with card
- No deadbolt

The Higher Security System Solitaire 850

This system is suitable for any facility that needs higher security, for up to 1,000,000 users and 100,000 doors. The best security you can offer is to encode your own custom cards using Kaba's proprietary encryption and a dedicated encoder and database, which you control. The database is Microsoft Access based.



Model 85250

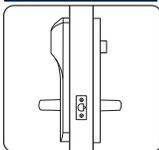

- Cylindrical Drive Lock
- Passage mode activated with thumbturn or card
- No deadbolt
- Auto Lock/Unlock

Model 85010

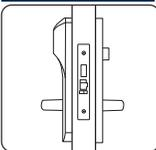

- Mortise Lock
- Passage mode activated with card
- 1" Deadbolt
- Auto Lock/Unlock

Model 85212

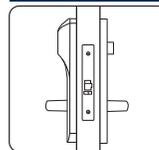

- Mortise Lock
- Passage mode activated with thumbturn or card
- No deadbolt
- Auto Lock/Unlock

The Compatible System Solitaire 950

Ideal for any company or institution that already has an ID badge system using the credit card encoding standard. This access system supports up to 1,000,000 users and 100,000 doors, and can use your existing ID cards with a magnetic stripe and import the user database you have on file. The Database is Microsoft SQL based and is networkable.



Model 95250

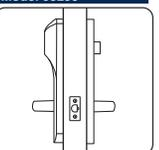

- Cylindrical Drive Lock
- Passage mode activated with thumbturn or card
- Auto Lock/Unlock

Model 95010

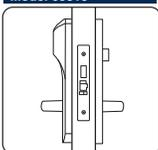

- Mortise Lock
- Passage mode activated with card
- 1" Deadbolt
- Auto Lock/Unlock

Model 95212



- Mortise Lock
- Passage mode activated with thumbturn or card
- No deadbolt
- Auto Lock/Unlock