

ES 400 System

Hospital sliding door operator



ES 400 System – reliable and powerful in compact design

Especially suitable for application in hospitals

As a compact and innovative sliding door operator, the ES 400 is especially suitable for application in hospitals, institutes or laboratories.

Thanks to its simple and low-maintenance design, it guarantees easy handling and reliable function as well as a long life cycle.

For single- and double-panel doors

The ES 410 effortlessly operates single-panel doors with a weight of up to 200 kg at a passage width of up to 3 m, while the ES 420 is especially suitable for double-panel doors with a door-panel weight of up to 2 x 125 kg.

We have just added the telescopic ES 415 sliding door operator to our program range. Thanks to its slender dimensions and its various ES 410 components, this operator for single-panel doors perfectly complements our ES 400 system.

Due to their high operating dynamics, all operators provide smooth operating behaviour combined with excellent operating characteristics. The respective risk assessment will show which safety devices according to DIN 18650 and EN 16005 (Germany) are required. German type approval according to DIN 18650: 21201004 and EN 16005.

Features and benefits

- Compact design
- Excellent operating dynamics
- Applicable for heavy doors in stainless steel design
- Self-learning
- Parameterisation via software
- Push & Go function
- Separate input for control via fire detection system
- Integrated airlock function for up to 3 door sets
- Automatic changeover to manual closing
- Automatische Umstellung auf manuelle Schließung

Cross section

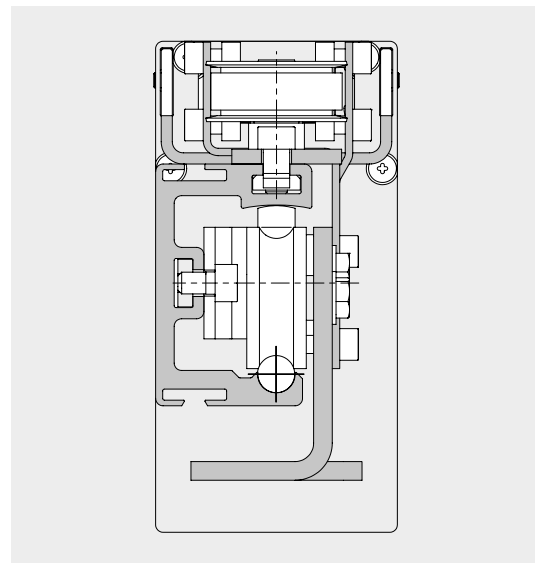

Drive unit





Door parameters	
Single-panel sliding door (ES 410)	700 – 3000 mm
– Clear passage width (LW)	1 x 200 kg
– Max. weight per door panel	1 x 250 kg
– with adapter unit weight leaf	
Double-panel sliding door (ES 420)	800 – 3000 mm
– Clear passage width LW	2 x 125 kg
– Max. weight per door panel	
Double-panel sliding door (ES 415)	1000 – 3000 mm
– Clear passage width LW	2 x 130 kg
– Max. weight per door panel	

Technical operator data	
Height	132 mm
Installation depth ES 410/ES 420	65 mm
ES 415	138 mm
Max. opening and closing force 150 N	●
Opening speed (adjustable)	10 – 50 cm/s
Closing speed (adjustable)	10 – 50 cm/s
Hold-open time	0 – 60 s
– Nurse opening of Nurse-Bed-Function (partial open)	0 – 60 s
– Bed opening of Nurse-Bed-Function	
Supply voltage, frequency	230 V, 50/60 Hz
Power consumption	180 W
Class of protection	IP 20
Temperature range	+ 0 – + 40 °C
Compliant with the Low Voltage Directive	●
Manufactured to ISO 9001	●

Control unit	
Microprocessor control Function programs	– Off ●
	– Permanent Open ●
	– Nurse opening of Nurse-Bed-Function (partial open) ●
	– Bed opening of Nurse-Bed-Function (full opening width) ●
	– Changeover (open/closed) ●
	– Airlock control (up to 3 connection boards) ●
Self-learning	●
Automatic reversing	●
Light barriers (max. 2 pairs)	●
24 V-output for external accessories	●

Accessories	
Light barriers	○
Emergency power supply unit USV	○

For structural heights of less than 2500 mm, a protective cover has to be installed by others.

● Standard ○ Optional



Control unit

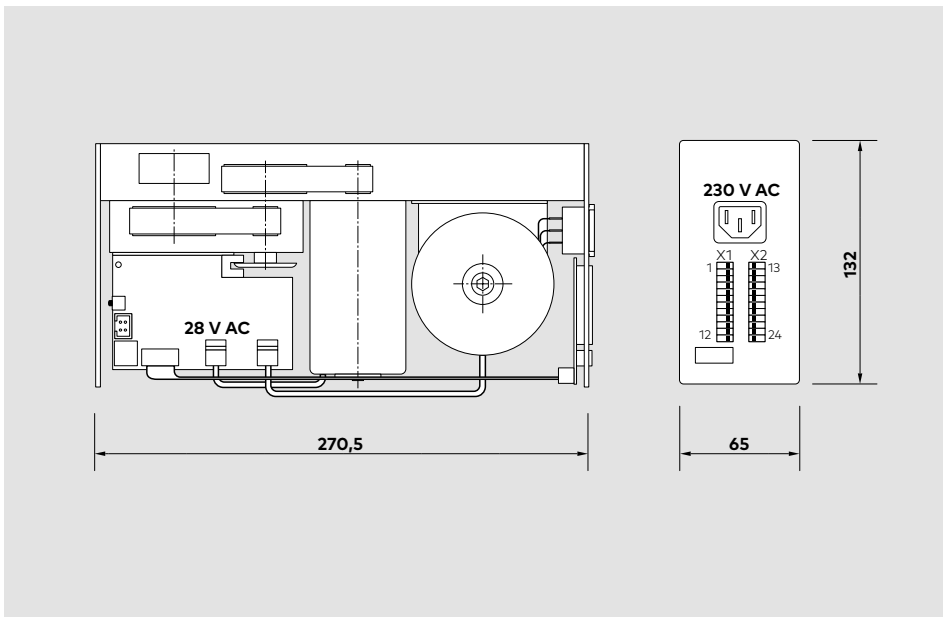

Thanks to its especially compact design, the operator may be installed in all buildings with standard door frames.

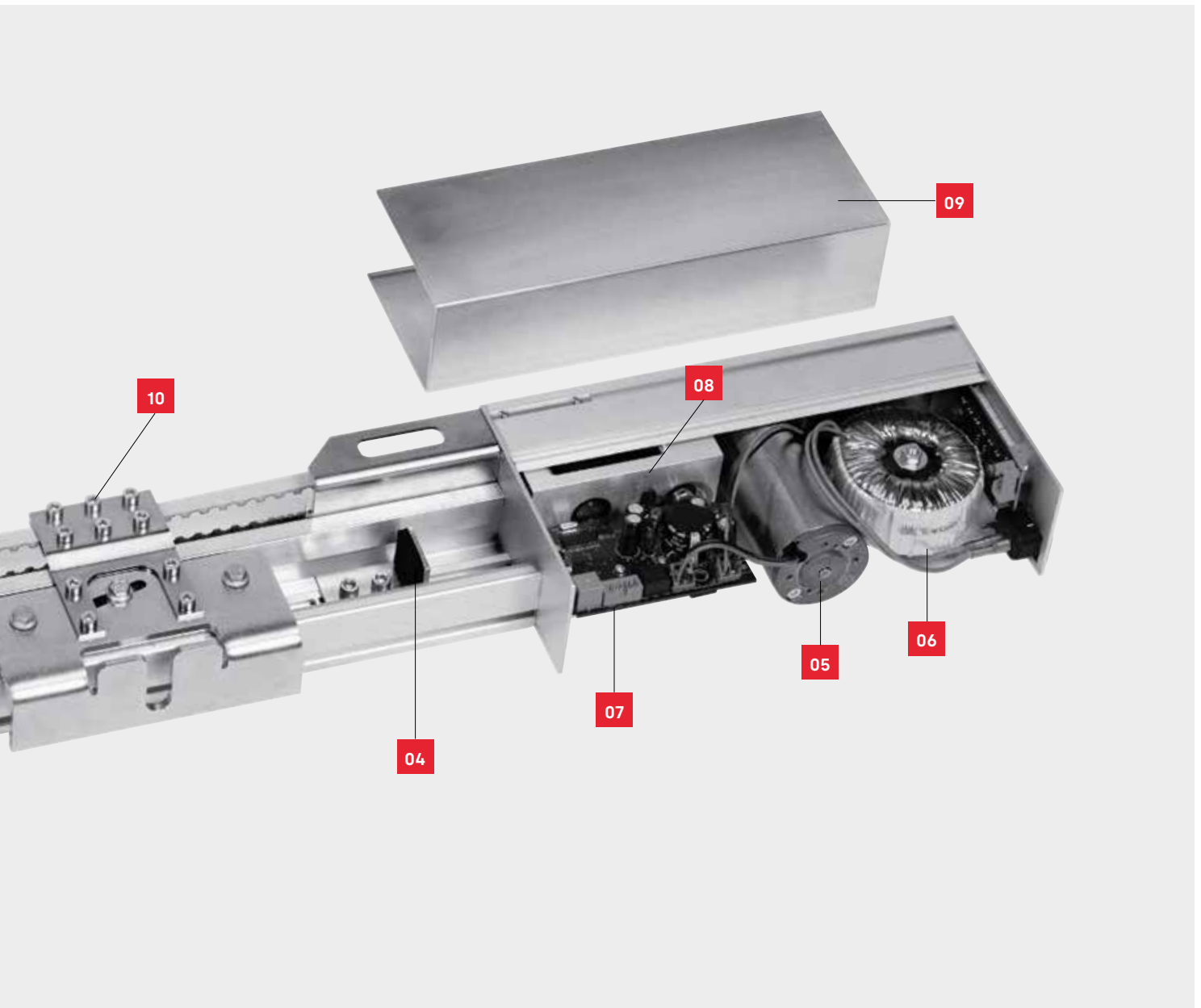

The core piece of the ES 400

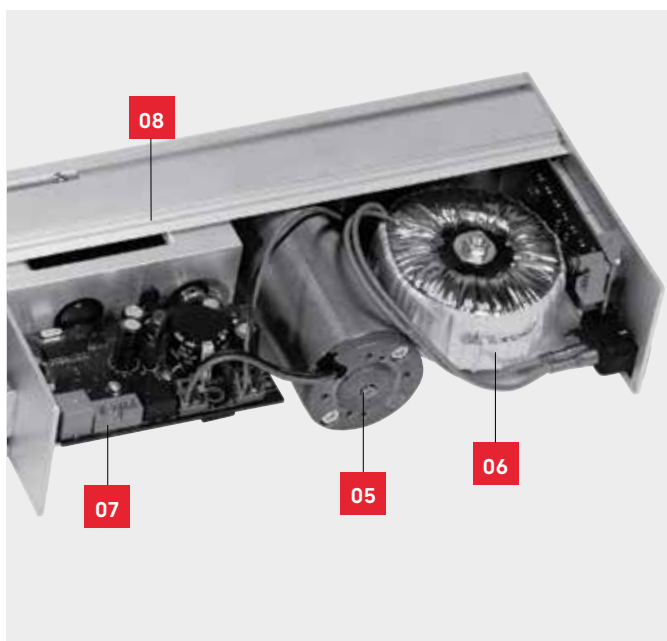

The prefabricated drive unit consists of all required electrical components and is tested individually thus facilitating the assembly and maintenance of the operator.

Components

- 1 Pulley (locking device)
- 2 Toothed belt
- 3 Carrier head
- 4 End stop
- 10 Tapped

Operator

- 5 Motor
- 6 Transformer
- 7 Control unit
- 8 Gear
- 9 Cover

Connections

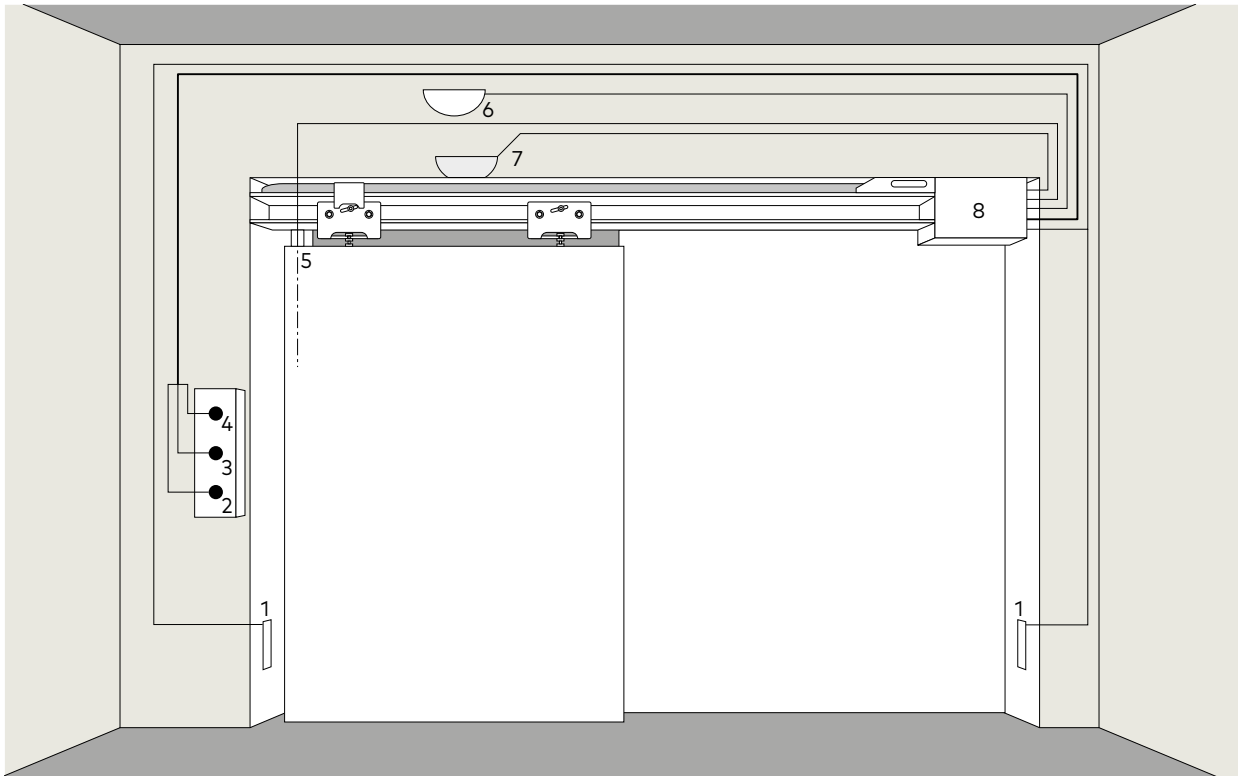

System component	System cable
1 Light barrier/safety sensor	4 x 0,5
2 Activator "Open"	2 x 0,5
3 Activator "Partial Open"	2 x 0,5
4 Activator "Permanent Open"	2 x 0,5
5 Contact for limit switch	2 x 0,5
6 External motion detector	4 x 0,5
7 Internal motion detector	4 x 0,5
8 Control unit	

Pushbutton (elbow)

Large-sized pushbutton (elbow)

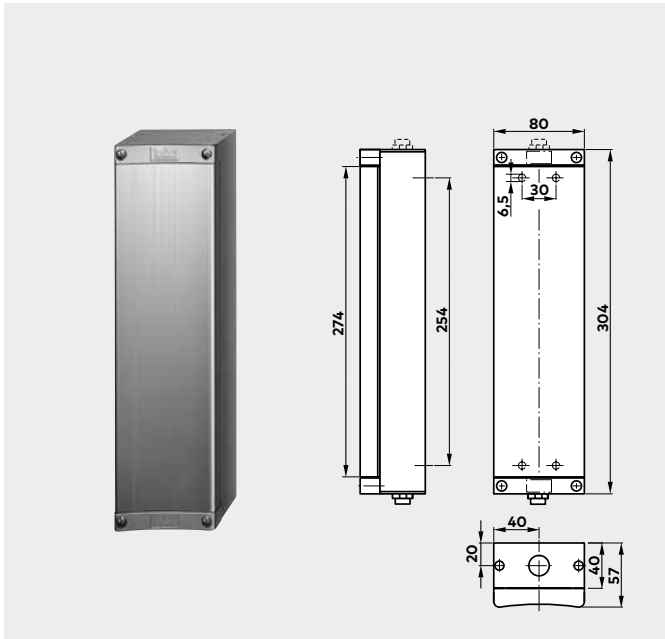

	Colour	Order No.
Flush-mounted version/ surface-mounted version, electrical, 304 x 80 mm	silver- coloured	90410015

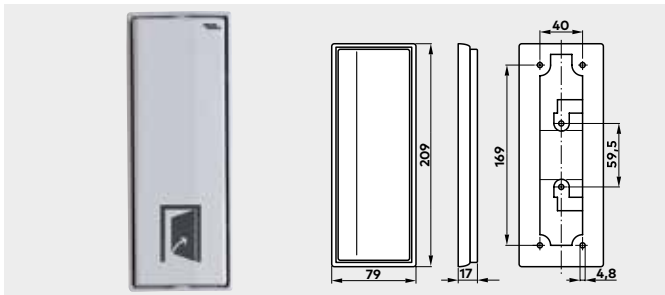

	Colour	Order No.
Surface-mounted version, extra-flat design, plastic, 209 x 79 x 17 mm	Grey	05080231332

Large-sized pushbuttons

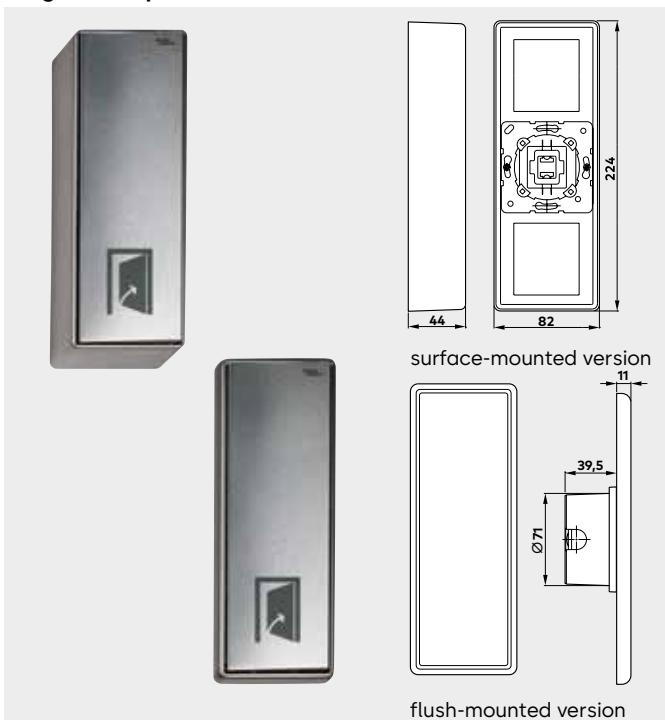







Large-sized pushbuttons	Colour	Order No.
With box for flush-mounting, without switch pad, incl. switch, 224 x 82 mm	silver- coloured	05095531332
With box for surface-mounting, without switch pad, incl. switch, paint box for surface-mounting, 224 x 82 x 44 mm	silver- coloured	05095231332

Switch pad	Order No.
Stainless-steel, suitable for surface-mounted version/ flush-mounted version, 214 x 70 mm	05095431332
Stainless-steel, suitable for surface-mounted version/ flush-mounted version, 214 x 70 mm, lettering "Tür auf" (German for "open door") (No picture)	05095331332

Stainless steel pushbuttons (Component system)



Centre insert consisting of switch pad and frame must be combined and ordered separately.

Switch pad	Designation	Specification	Installation System	Order No.
	Centre insert*	Centre insert, pushbutton with single-pole changeover contact, for flush-mounting		5157633332
	Frame*	Single-type, stainless steel, 81 x 81 mm	Stainless steel	5157833332
	Neutral		Stainless steel	5157233332
	Tür auf	Switch pad with lettering "Tür auf" (German for "open door")	Stainless steel	5157033332
	Nurse opening (partial open)	Partial opening for "nurse-opening" of Nurse-Bed-Function	Stainless steel	5157133332
	Bed opening (full opening width)	Full opening width for "bed opening" of Nurse-Bed-Function (Automatic function)	Stainless steel	5157533332
	Permanent Open (full opening width)	Permanent full opening width for "Permanent Open" function	Stainless steel	5157333332
	Disabled symbol	Disabled symbol	Stainless steel	5157433332
	Lock and unlock	To lock and unlock, used in toilets for the disabled in conjunction with a switch, lock symbols for locked/unlocked	Stainless steel	5156933332
	Sealing kit IP 44*	Sealing kit IP 44 (only for stainless steel range)		5157733332

Box for surface-mounting for stainless steel range	Designation	Specification	Installation system	Order No.
	Box for surface mounting*	Single-type, paint sprayed for stainless steel effect	Stainless steel	5156933332

* no picture

Special switches

	Designation	Specification	Order No.
	Foot pushbutton (Mushroom pushbutton)	Foot switch in heavy design with black plastic housing. Mushroom-style pushbutton with a diameter of 94 mm. Impact resistant plastic for application in heavily used areas, class of protection: IP 67 Equipped with one NO contact, 98 x 83 x 85 mm (height x length x width)	5026931332
	Pull switch ZT	10 A, 380 V DC, IP 65, incl. fixing brackets and cord, plastic ball end, for surface-mounting	90410020

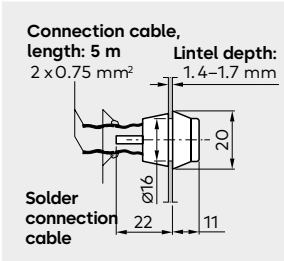
Jamb-concealed pushbutton	Designation	Specification	Colour	Order No
 <p>Connection cable, length: 5 m Lintel depth: 1.4-1.7 mm Solder connection cable</p>	Pushbutton	Single-pole NO contact for snap-in mounting, frame depth 1.4-1.7 mm	grey orange white	5020633332 5043933332 5132833332
	Connection Cable	5 m, 2 x 0,75 mm ²		90410021

Code switch CT 4/1 (Keypad and electronics module have to be combined)



The CT 4/1 code switch is a modern and safe alternative to common key switches. The CT is ready for use after two simple programming steps. The data is transferred coded and is thus protected against manipulation.

The respective control unit must be ordered separately 230 V/50 Hz, 1.5 VA, 1 x UM potential-free (floating) relay contact 8 A, 250 V, Connections: max. 2.5 mm



	Designation	Specification	Colour	Order No.
	MTB 4/1 Metal keypad	for entering the opening code and for programming purposes, for surface-mounting, 75 x 75 x 11.5 mm		05079331332
	EB 4/1*	Electronics module, incl. connection cable (2 m), plastic housing, black, for surface-mounting	black	05063431332

* no picture



Emergency pushbuttons

	Designation	Specification	Installation system	Order No.
	NAT	Designed to interrupt the automatic movement of the door, emergency push-button (function: Emergency Off) for automatic door operators, manufactured to ZH 1/494 or BGR 232, DIN 18650 and EN 16005, red knob with yellow centre insert, max. load current: 10 A at 230 V AC		
	NAT 1	NO contact: 1, NC contact: 1, white frame, flush-mounted version, 80 x 80 mm	System 55	90400025
	NAT 2 (no picture)	Function "Emergency Opening" with green knob, NO contact: 1, NC contact: 1, max. load current: 10 A at 230 V AC, white frame, flush-mounted version, 80 x 80 mm	System 55	90400035
	NAT 4	NO contact: 1, NC contact: 1, surface-mounted version, 68 x 68 mm		05027031332
	TL-N S55	Highly-illuminated emergency pushbutton environment with visual locking status indication, optical and acoustic alarm via yellow flashlight and integrated alarm siren, sabotage-proof, behind glass, not including frame NO contact: 1, NC contact: 1, max. load current: 1 A at 24 V DC, flush-mounted version, 80 x 80 mm	System 55	56330500
				



Active infrared detectors

Safety sensors	Designation	Specification	Colour	Order No.
	Prosecure Opti Scan	The active infrared curtain according to EN 16005 ensures optimum protection of the area at the side of the door. It protects people in the danger area of the opening door panel.	black silver coloured white	86301100 86302100 86303100
	Prosecure Opti Scan 1	The active infrared curtain according to DIN 18650 and EN 16005 ensures optimum protection of the area at the side of the door. It protects people in the danger area of the opening door panel.	black silver coloured white	86301101 86302101 86303101
Combi sensors	Designation	Specification	Colour	Order No.
	Prosecure Opti Combi	Quick and easy to install, wide field can be used as a light barrier substitute, LCD Display, Precise positioning of the AIR curtain thanks to inclination angle display on a clear scale, direction recognition (DIN 18650 and EN 16005)	black silver coloured white	86711400 86712400 86713400
	Prosecure Opti Combi 1	Very flexible field settings, active infrared curtain is self-monitoring, crossing traffic optimization, precise positioning of the AIR curtain thanks to inclination angle display on a clear scale, direction recognition. (DIN 18650 and EN 16005)	black silver coloured white	86711401 86712401 86713401

Motion detectors

	Designation	Specification	Colour	Order No.
	Prosecure Easy Motion Mono	Full-automatic access on pulse activation; adjustable inclination angle, inclined field of view and field size, LED status indicator, not in accordance with EN 16005 Ambient temperature -20 °C to 60 °C	black silver coloured white	86001000 86002000 86003000
	Prosecure Easy Motion Stereo	Adjustable inclination angle, inclined field of view and field size, direction recognition, cross-traffic suppression, immunity, LED status indicator, not in accordance with EN 16005 Ambient temperature -20 °C to 60 °C	black silver coloured white	86011000 86012000 86013000
	Prosecure Opti Motion Mono	Adjustable inclination angle, inclined field of view and field size, direction recognition, immunity, LED status indicator Ambient temperature -20 °C to 60 °C	black silver coloured white	86101000 86102000 86103000
	Prosecure Opti Motion Stereo	Adjustable inclination angle, inclined field of view and field size, direction recognition, cross-traffic suppression, Slow Motion function, immunity, LED status indicator Ambient temperature -20 °C to 60 °C	black silver coloured white	86111000 86112000 86113000

Accessories

Accessories	Designation	Specification	Order No.
	Rain protection cover	For Easy Motion detectors	86031900
	Rain protection cover/ceiling angle bracket	For Opti Motion detectors	86131900
	Prosecure Remote Control	Remote control for programming Prosecure Opti Motion detectors or products from other brands, for the convenient and exact adjustment of high-mounted sensors, self-explaining menu navigation, LCD display, ambient temperature -20 °C to 60 °C	86991900

Our Sustainability Commitment

We are committed to foster a sustainable development along our entire value chain in line with our economic, environmental and social responsibilities toward current and future generations. Sustainability at product level is an important, future-oriented approach in the field of construction. In order to give quantified disclosures of a product's environmental impact through its entire life cycle, dormakaba provides Environmental Product Declarations (EPD), based on holistic life cycle assessments.

www.dormakaba.com/sustainability



Our offering

Access Automation Solutions

Entrance Automation
Entrance Security



Access Control Solutions

Electronic Access & Data
Escape and Rescue Systems
Lodging Systems



Access Hardware Solutions

Door Closers
Architectural Hardware
Mechanical Key Systems



Services

Technical Support
Installation and commissioning
Maintenance and Repair



WN 053965 51532, EN, 10/2023
Subject to change without notice



dormakaba.com

dormakaba
International Holding AG
Hofwissenstrasse 24
CH-8153 Rümlang
T +41 44 818 90 11
info@dormakaba.com
dormakaba.com