

M1000

Grade 1 Mortise Locksets



Table of contents

M1000 Series		Functions	
3	Features	8	Available Functions
4	Technical Details/Specifications		
How to Order		Electromechanical Options	
5	Locks	14	Electrical Requirements
6	Keyways	14	Monitoring Options
Trim Options		Lock Options	
7	M1000 Standard Levers	15	4-7/8" Non-Handed Strike
7	M1000 Premium Levers	15	4-7/8" Handed Strike
7	Wrought Roses	15	Tactile Warning (Knurling)
7	Escutcheons Functions	15	Occupancy Indicators



dormakabakaba USA quality and environmental management systems in Indianapolis, IN are certified to ISO 9001:2015 and ISO 14001:2015.

M1000 Series

Exceptional security, enhanced aesthetics, and rugged dependability.

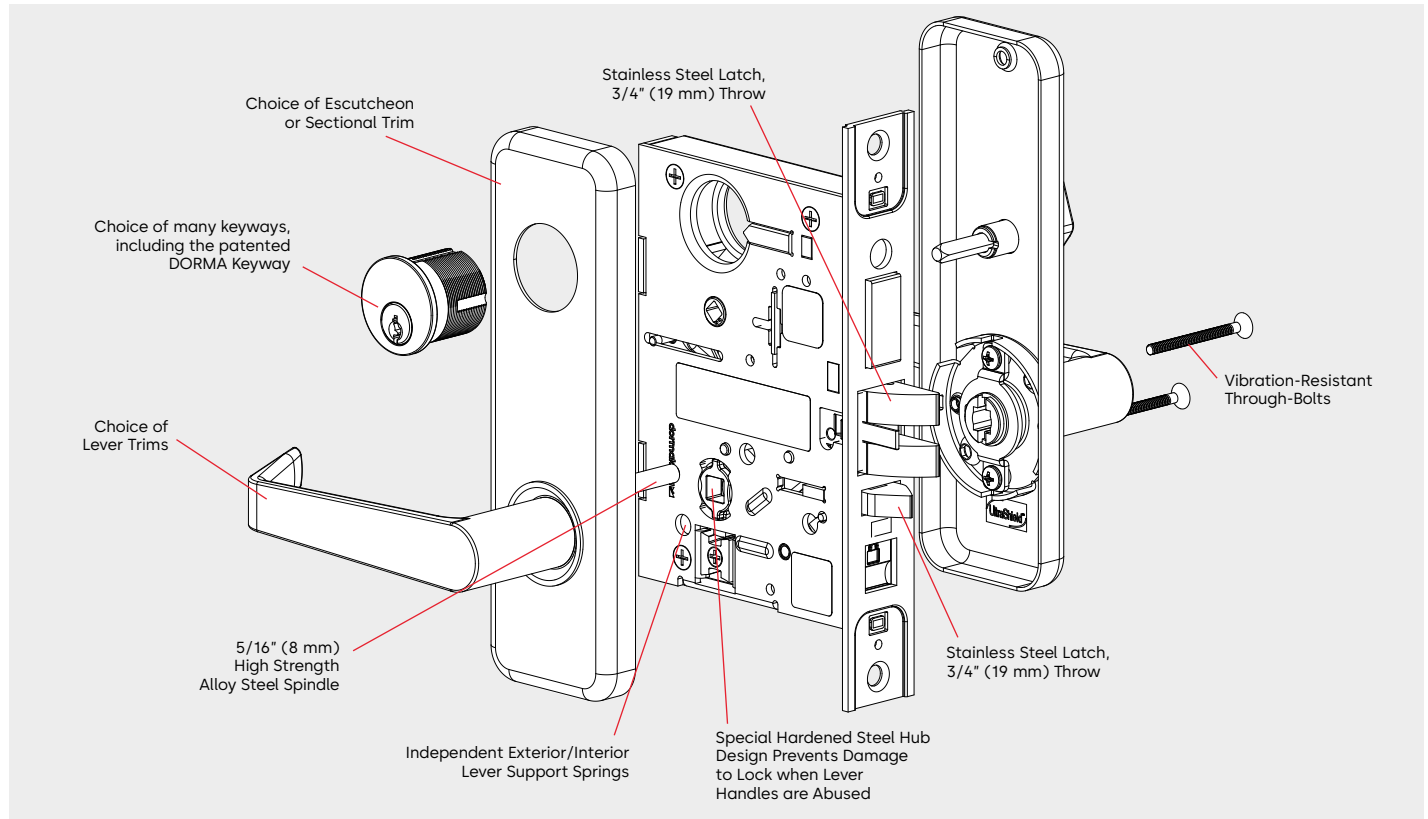

These premium performance locksets are built with a heavy-duty mortise chassis for all applications where ANSI/BHMA A156.13 Grade 1 products are required. To meet the aesthetic needs of your project, these versatile locks are available in a range of lever designs and finishes.

Features

- M1000 Series mortise locks feature advanced design concepts for extreme reliability and are manufactured with the finest materials for exceptional durability
- M1000 locks provide a wide variety of functions and the most popular finishes
- Special, high-strength springs and a positive stop eliminate unsightly sagging levers
- Select components are manufactured with high-strength steel or stainless steel, providing an extremely strong, highly durable lock
- Trims utilize 5/16" (8 mm) high-strength alloy steel spindles for extra durability.
- Levers, roses, and escutcheons are manufactured from brass, bronze, or stainless steel
- Field reversible latch bolt is easily changed in seconds
- All levers—solid cast/forged brass or stainless
- All roses—wrought brass or stainless
- Escutcheons—H: cast/forged brass or stainless
M: wrought brass or stainless

Recommended Applications

Schools and Universities
Hotels
Apartments
Hospitals and Nursing Homes
Churches
Municipal Buildings
Airports
Retail Complexes
Offices
Warehouses



Technical Details

- Standard door thickness
- 1-3/4"–2-1/4"
- 2-3/4" backset
- Stainless steel dead bolt for strength, durability, and saw resistance
- Security spacer between inside and outside lever hubs in lock case protects lock from unauthorized entry and vandalism
- Steel lock case and internal components provide additional strength
- Pivoting face plate allows lock case to fit flat face, standard bevel, and reverse bevel door applications
- Full length interlocking face plate supports both the latch and dead bolts against forced entry
- Mortise case chassis can be easily handed in the field
- All trim through-bolted through the lock case for positive alignment
- Universal non-handed curve lip strike for all functions
- Accepts standard, Small and Large Interchangeable Core Cylinders

Cylinders & Keying

- Unless otherwise specified, cylinders will be provided in SC keyway with two (2) nickel silver keys
- Optional patented key system available
- All cylinder type options will utilize the dormakaba 19 cam except on the outside cylinder on M1060 will utilize the dormakaba 10 cam.

Certification/ Compliance

- Certified to A156.13 Series 1000, operational and security Grade 1
- Meets A117.1 accessibility code and ADA requirements for barrier-free accessibility
- UL listed 3 hour fire rated. Mortise type with 3/4 in. latch bolt, Series M1000. Available with brass, bronze, or stainless-steel lever handles. May be used on fire doors rated 3 hrs or less in sizes up to 4 ft. in width and 10 ft. in height.
- Meets California State Reference Code (formerly title 19, California State Fire Marshall standard)
- All levers with returns, return to within 1/2" (13 mm) of door face

Finishes

- 605 Bright Brass
- 606 Satin Brass
- 612 Satin Bronze
- 613 Dark Oxidized Satin Bronze
- 618 Bright Nickel
- 619 Satin Nickel
- 622 Satin Black
- 625 Bright Chrome
- 626 Satin Chrome
- 629 Bright Stainless
- 630 Satin Stainless

Antimicrobial Protected Coating

Specify AM

Special Finish Notes

ANSI/BHMA A156.18 standards describe 613 Dark Oxidized Satin Bronze finish as a category B finish. B category finishes, "do not match from one alloy or form of material to the next and from one manufacturer to the next." The 613 finish may vary between manufacturers' products and models.

In some instances, for customer convenience, the most appropriate BHMA finish symbols are used to indicate similarity of appearance, regardless of base metal or finishing process. Finishes of latches, strikes, cylinders/cores, and visible mounting screws, though similar in appearance, may differ from the finish of the trim. Finish designations in the 600 numbers are the BHMA (Builders Hardware Manufacturers Association) industry standard.

Security Screws

Torx® tamper-resistant screws are available for all exposed screws. Specify TX.

Warranty

For details, refer to **Limited Warranty** on our website at dormakaba.us.

How to order M1000 Series locks

Function¹

Privacy w/DB & Indicator	996
Faculty Restroom/Hotel w/DB & Indicator	986
Storeroom w/DB Single Cylinder	980
Dormitory w/DB (F21)	973
Intruder Dead Bolt (F33)	968
Intruder Dead Bolt (F34)	967
Storeroom w/DB (F14)	966
Storeroom w/DB (F35)	958
Dormitory w/DB (F11)	957
Corridor w/DB (F13)	956
Entry w/DB (F20)	953
Privacy w/DB (F19)	940
Institution (F30)	082
Electrically Unlocked/Locked w/Double Locking	082EU/EL
Electrically Unlocked/Locked	080EU/EL
Storeroom (F07)	080
Storeroom Single Sided	079
Classroom Intruder Latch Bolt (F32)	071
Classroom (F05)	070
Classroom Single Sided	069
Apartment (F09)	060
Office/Entry (Alt F04)	053
Office/Entry (F04)	050
Privacy, w/Indicator	047
Privacy, w/Coin Turn	043
Privacy, Bedroom or Bath	041
Exit/Communicating Passage	026
Exit/Communicating Passage (F31)	025
Passage/Closet (F01)	010
Dummy Trim Two Sides	002
Dummy Trim One Side	001

- Additional functions available.
- D rose only available in 629 and 630
- Antimicrobial coating available in 626 and 630 finishes only. Not available on 630 H escutcheon.
- Security Screws only available with 619, 625, 626 and 630 finishes.
- Standard door thickness is 1-3/4" (44 mm). Requirements for doors 1-13/16" (46 mm) and thicker can vary by trim and function. Consult factory for these special applications.
- Example shows default values. Refer to Lock Options section for full details.

Lever Design

Premium Lever	PREMIUM
Lever	LT
Lever	LR
Lever	LN
Lever	LG
Lever	LD
Lever	LC

Finish

630	Satin Stainless
629	Bright Stainless
626	Satin Chrome
625	Bright Chrome
622	Satin Black
619	Satin Nickel
618	Bright Nickel
613	Dark Oxidized Satin Bronze
612	Satin Bronze
606	Satin Brass
605	Bright Brass

Door Thickness⁵

Strike Options⁶

Lip Length⁶

M1	953	D	LR	A	626			RH	134	5006	114	XXXX
-----------	------------	----------	-----------	----------	------------	--	--	-----------	------------	-------------	------------	-------------

Product Family	Temporary SFIC — T	SFIC (Less Core) — J	Less Cylinder — L	Conventional Cylinder — D	Temporary Schlage LFIC — G	Schlage LFIC (Less Core) — R						
----------------	---------------------------	-----------------------------	--------------------------	----------------------------------	-----------------------------------	-------------------------------------	--	--	--	--	--	--

Cylinder Type

--	--	--	--	--	--	--	--	--	--	--	--	--

Rose/Escutcheon Design

--	--	--	--	--	--	--	--	--	--	--	--	--

Door Hand

--	--	--	--	--	--	--	--	--	--	--	--	--

Security Screws⁴

--	--	--	--	--	--	--	--	--	--	--	--	--

Antimicrobial Coating³

--	--	--	--	--	--	--	--	--	--	--	--	--

Keying Options Field

How to order Keyways

Standard Keyways

Keying

- OBIT** – 0-Bitted
- 1BIT** – 1BIT - 1 - Bitted
- CMK** – Construction Master Keyed
- MKD** – Master Keyed
- NSK** – Keyed Alike, Sets of 3 or More
- KA2** – Keyed Alike, Sets of 2
- KD** – Keyed Different

SC
KD

- SC** – Schlage C
- SE** – Schlage E
- D100** – DORMA SKC
- D200** – DORMA SKC
- D300** – DORMA SKC
- D400** – DORMA SKC

- AA** – Arrow A
- CA** – Corbin 60
- CB** – Corbin 67
- CC** – Corbin 77
- CD** – Corbin 59A1
- CE** – CorbinRusswin L4
- RA** – Russwin 981
- RB** – Russwin D1
- GA** – Sargent LA
- SF** – Schlage F
- YA** – Yale 8
- YG** – Yale GA

Keyway

IC Keyways

Keying

- TMP** – Temporary Construction Core
- MKD** – Combinated (Master Keyed)

BA
MKD

- BA** – Best A
- BB** – Best B
- BC** – Best C
- BD** – Best D
- BE** – Best E
- BF** – Best F
- BG** – Best G
- BH** – Best H
- BJ** – Best J
- BK** – Best K
- BL** – Best L
- BM** – Best M
- BQ** – Best Q
- TB** – Best TB
- D100** – DORMA SKC (7-pin Core only)
- D200** – DORMA SKC
- D300** – DORMA SKC
- D400** – DORMA SKC

- BLK** – Black Construction Core
- BLU** – Blue Construction Core
- GRN** – Green Construction Core

Keyway

Retrofit Keyways Available 0-Bitted Only

Specify Color If Required to Match Existing Project

Trim options

Lever options – Standard

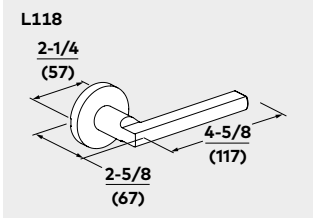
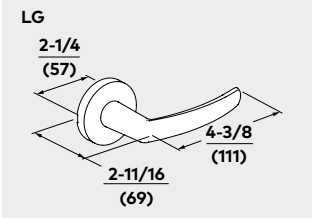
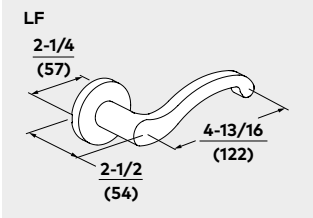
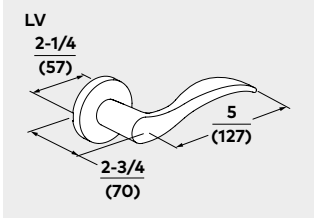
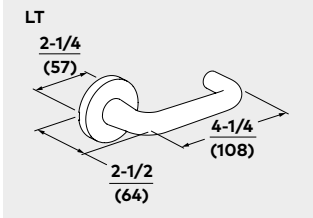
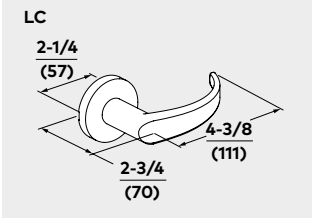
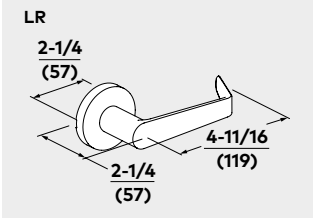

Lever options – Premium

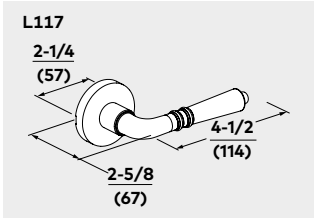
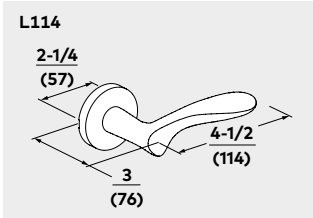
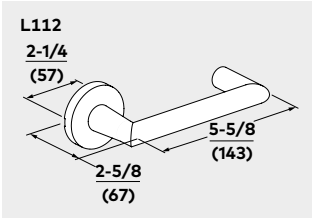
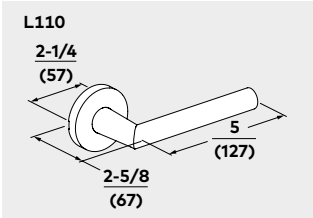
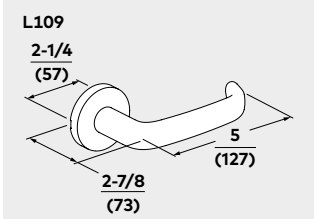
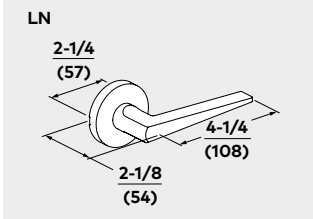
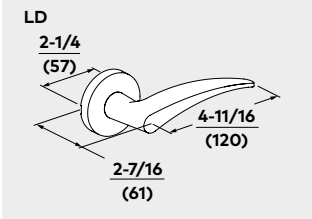
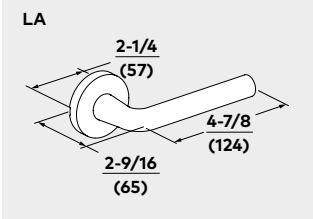

Trim styles

D rose only available in 629 and 630

Wrought roses

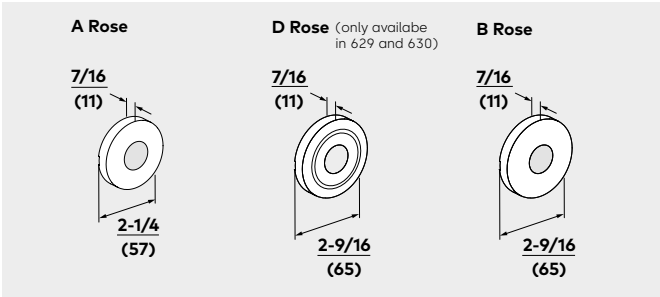

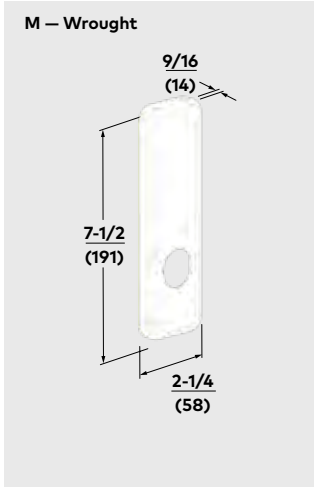
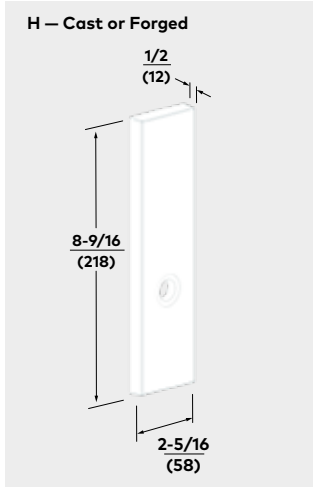

NOTE: Levers with returns return to within 1/2" (13 mm) of the door face.

Escutcheons

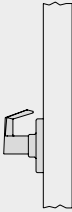
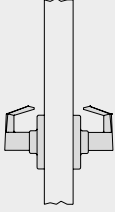
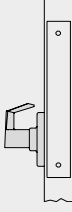
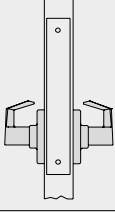
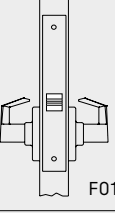
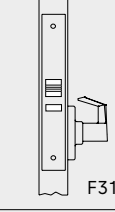
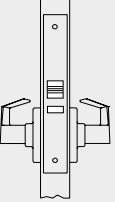

Functions

Function	Series	Outside/Inside	Description
Dummy Trim One Side	M1001		<ul style="list-style-type: none"> Used as pull or matching trim on pairs of doors.
Dummy Trim Two Sides	M1002		<ul style="list-style-type: none"> Used as pull or matching trim on pairs of doors.
Dummy Trim One Side	M1003 (w/lockcase)		<ul style="list-style-type: none"> Used as pull or matching trim on pairs of doors. Trim always rigid.
Dummy Trim Two Sides	M1004 (w/lockcase)		<ul style="list-style-type: none"> Used as pull or matching trim on pairs of doors. Trim always rigid.
Passage/Closet	M1010	 F01	<ul style="list-style-type: none"> Latch bolt operated by trim either side.
Exit/Communicating Passage	M1025	 F31	<ul style="list-style-type: none"> Latch bolt operated by trim either side. Blank trim or no outside trim. Auxiliary latch deadlocks latch bolt.
Exit/Communicating Passage	M1026		<ul style="list-style-type: none"> Latch bolt operated by trim either side Auxiliary latch deadlocks latch bolt.

 Indicates rigid lever.

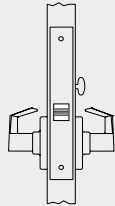
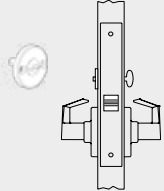
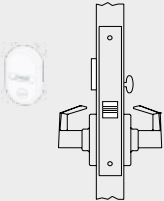
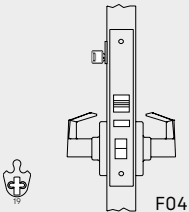
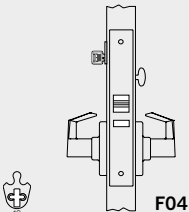
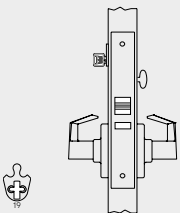
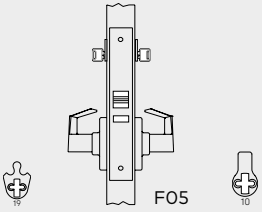
Function	Series	Outside/Inside	Description
Privacy, Bedroom or Bath	M1041		<ul style="list-style-type: none"> Latch bolt operated by trim either side, except when outside trim locked by inside turn. When locked, outside trim unlocked by inside trim by closing door, by rotating inside turn, or by emergency release.
Privacy, Bedroom or Bath	M1043		<ul style="list-style-type: none"> Latch bolt operated by trim either side, except when outside trim locked by inside turn or coin turn outside. When locked, outside trim unlocked by inside trim by closing door, by rotating inside turn, or by rotating coin turn outside.
Privacy with Indicator	M1047		<ul style="list-style-type: none"> Latch bolt operated by trim either side, except when outside trim locked by inside turn. When locked, outside trim unlocked by inside trim by rotating inside turn, or by coin turn outside. When outside trim is locked, "OCCUPIED" message is displayed. Latch bolt deadlocked with outside trim is locked.
Office/Entry	M1050		<ul style="list-style-type: none"> Latch bolt operated by trim either side, except when outside trim locked by stopworks. When outside trim locked, latch bolt retracted by key outside or operated by inside trim. Auxiliary latch deadlocks latch bolt.
Office/Entry	M1053		<ul style="list-style-type: none"> Latch bolt operated by trim either side, except when outside trim locked by key outside or by inside turn When outside trim locked, latch bolt retracted by key outside or by inside trim. Outside trim remains locked until inside turn rotated to unlocked position or unlocked by key. Auxiliary latch deadlocks latch bolt when door locked.
Office/Entry with Automatic Unlocking	M1056		<ul style="list-style-type: none"> Latch bolt operated by trim either side, except when outside trim locked by key outside or by inside turn. When outside trim locked, latch bolt retracted by key outside or by inside trim. Outside trim unlocked by key outside or by inside turn. Rotating inside trim simultaneously retracts latch bolt and unlocks outside trim. Auxiliary latch deadlocks latch bolt when door locked.
Apartment	M1060		<ul style="list-style-type: none"> Latch bolt operated by trim either side, except when outside trim locked by key inside. When outside trim locked, latch bolt retracted by key outside or by inside trim. Auxiliary latch deadlocks latch bolt.

 Indicates rigid lever.

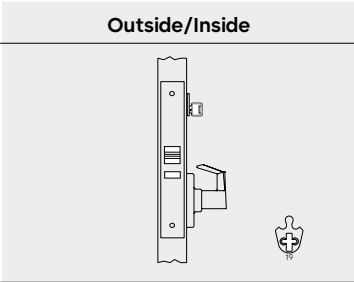
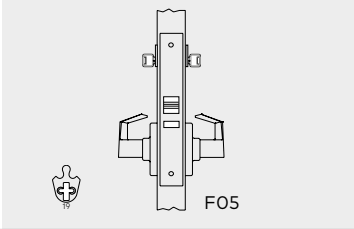
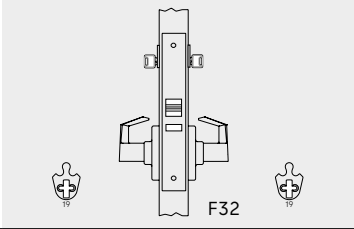
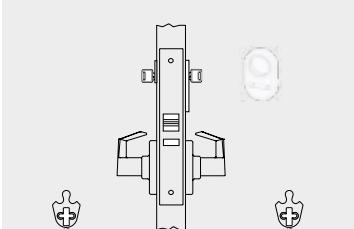
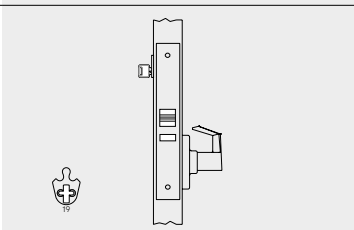
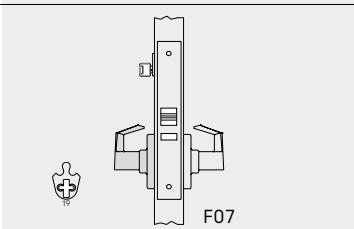
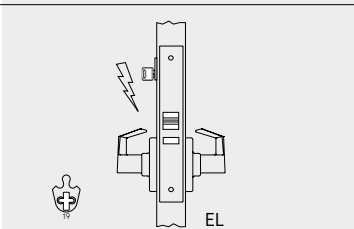
Function	Series	Outside/Inside	Description
Classroom Single Sided	M1069		<ul style="list-style-type: none"> • Latch operated by turning key in outside cylinder or rotating the inside lever handle • Inside lever handle is always unlocked • No lever handle on the outside
Classroom	M1070		<ul style="list-style-type: none"> • Latch bolt operated by trim either side, except when outside trim locked by key outside. • When outside trim locked, latch bolt operated by inside trim • Auxiliary latch deadlocks latch bolt.
Classroom Intruder Latch Bolt	M1071		<ul style="list-style-type: none"> • Latch bolt operated by trim either side, except when outside trim locked by key either side. • When outside trim locked, latch bolt operated by key either side or by operating inside trim. • Auxiliary latch deadlocks latch bolt.
Classroom Intruder with Indicator (Sectional trim only)	M1072		<ul style="list-style-type: none"> • Latch bolt operated by trim either side, except when outside trim locked by key either side. • When outside trim locked, latch bolt operated by inside trim. • Auxiliary latch deadlocks latch bolt. • When outside trim locked, OCCUPIED message displayed inside. • When outside trim unlocked, VACANT displayed inside.
Storeroom Single Sided	M1079		<ul style="list-style-type: none"> • Latch bolt retracted by key outside • Outside trim always rigid. • Auxiliary latch deadlocks latch bolt
Storeroom	M1080		<ul style="list-style-type: none"> • Latch bolt retracted by key outside or operated by inside trim. • Outside trim always rigid. • Auxiliary latch deadlocks latch bolt.
Electrically Locked Fail Safe	M1080EL		<ul style="list-style-type: none"> • Outside trim locked when power is on. • Outside trim unlocked when power is interrupted. • Latch by key outside. • Inside trim always unlocked. • Auxiliary latch deadlocks latch bolt. <p>NOTE: Available with Request to Exit (RX), Latch Monitoring (LM) or both.</p>

 Indicates rigid lever.

CAUTION: Double cylinder locks on residences and any door in any structure which is used for egress are a life safety hazard in times of emergency and their use is not recommended. Installation should be in accordance with existing local codes only.

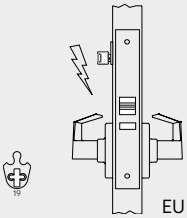
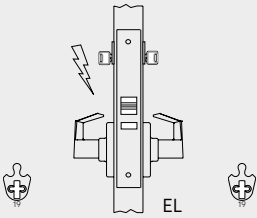
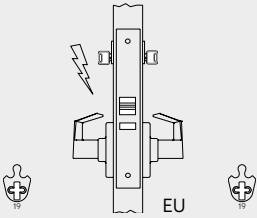
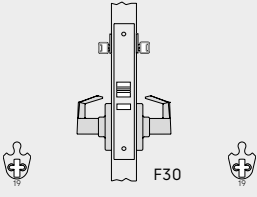
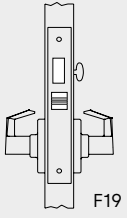
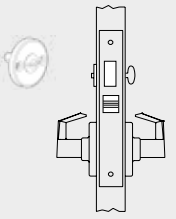
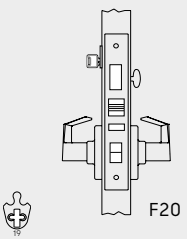
Function	Series	Outside/Inside	Description
Electrically Unlocked Fail Secure	M1080EU		<ul style="list-style-type: none"> • Outside trim unlocked when power is on. • Outside trim locked when power is interrupted. • Latch by key outside. . Inside trim always unlocked. • Auxiliary latch deadlocks latch bolt. <p>NOTE: Available with Request to Exit (RX), Latch Monitoring (LM) or both.</p>
Electrically Locked Fail Safe with Double Locking	M1082EL		<ul style="list-style-type: none"> • Outside and inside trim locked when power is on. • Outside and inside trim unlocked when power is interrupted. • Latch by key either side. • Auxiliary latch deadlocks latch bolt. <p>NOTE: Available with Request to Exit (RX) or Latch Monitoring (LM).</p>
Electrically Unlocked Fail Secure with Double Locking	M1082EU		<ul style="list-style-type: none"> • Outside and inside trim unlocked when power is on. • Outside and inside trim locked when power is interrupted. • Latch by key either side. • Auxiliary latch deadlocks latch bolt. <p>NOTE: Available with Request to Exit (RX) or Latch Monitoring (LM).</p>
Institution	M1082		<ul style="list-style-type: none"> • Latch bolt operated by key either side. • Auxiliary latch deadlocks latch bolt. • Trim both sides always rigid. <p>* Locksets that secure both sides of the door are controlled by building codes and the Life Safety Code. In an emergency exit situation, failure to quickly unlock the inside lever could be hazardous or even fatal.</p>
Privacy with Dead Bolt	M1940		<ul style="list-style-type: none"> • Latch bolt operated by trim either side, except when projected dead bolt locks outside trim and deadlocks latch. • Dead bolt operated by turn inside. • Dead bolt operated by emergency release outside. • Inside trim operates both bolts simultaneously and unlocks outside trim.
Privacy with Dead Bolt and Coin Turn Outside	M1942		<ul style="list-style-type: none"> • Latch bolt operated by trim either side, except when projected dead bolt locks outside trim and deadlocks latch. • Dead bolt operated by turn inside or coin turn outside. • Rotating outside coin turn retracts dead bolt and unlocks outside trim. • Inside trim operates both bolts simultaneously and unlocks outside trim.
Entry with Dead Bolt	M1953		<ul style="list-style-type: none"> • Latch bolt operated by trim either side, except when outside locked by stopworks. • Dead bolt operated by key outside or turn inside. • Key operates both dead bolt and latch bolt. • Inside lever operates both bolts; outside trim remains locked. • Latch bolt deadlocked when outside lever locked, or dead bolt projected. • When dead bolt retracted, outside trim unlocked by stopworks.

 Indicates rigid lever.

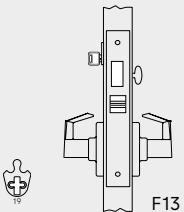
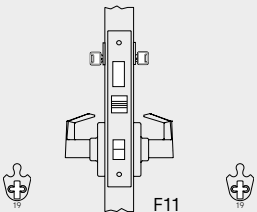
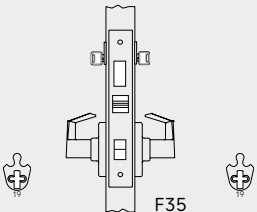
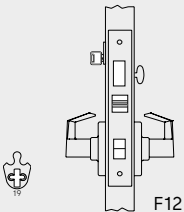
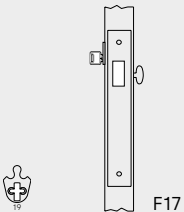
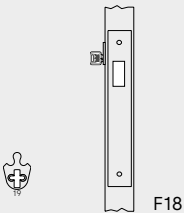
Function	Series	Outside/Inside	Description
Corridor with Dead Bolt	M1956	 F13	<ul style="list-style-type: none"> • Latch bolt operated by trim either side, except when projected dead bolt locks outside trim and deadlocks latch. • Dead bolt and latch retracted by key outside. • Dead bolt projected by turn inside or key outside. • Inside trim operates both bolts and unlocks outside trim.
Dormitory with Dead Bolt	M1957	 F11	<ul style="list-style-type: none"> • Latch bolt operated by trim either side, except when outside trim locked either by stopworks or projected dead bolt. • Dead bolt operated by key either side. • Dead bolt deadlocks latch bolt. • Inside trim operates both bolts simultaneously; outside trim remains locked.
Storeroom with Dead Bolt	M1958	 F35	<ul style="list-style-type: none"> • Latch bolt operated by trim either side, except when outside trim locked by stopworks. • Dead bolt operated by key either side. • Latch bolt operated by inside lever.
Dormitory/Exit with Dead Bolt	M1959	 F12	<ul style="list-style-type: none"> • Latch bolt operated by trim either side, except when outside trim locked either by stopworks or projected dead bolt. • Dead bolt operated by key outside or turn inside. • Dead bolt deadlocks latch bolt. • Inside trim operates both bolts simultaneously; outside trim remains locked.
Cylinder x Turn Dead Bolt (only)	M1960	 F17	<ul style="list-style-type: none"> • Dead bolt operated by key outside or by turn inside.
Cylinder x Blank Dead Bolt (only)	M1961	 F18	<ul style="list-style-type: none"> • Dead bolt operated by key outside only.



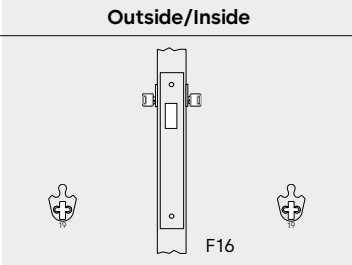
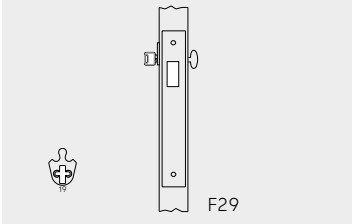
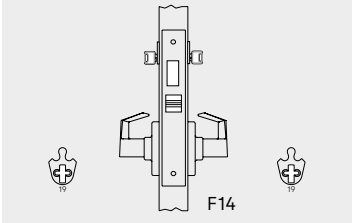
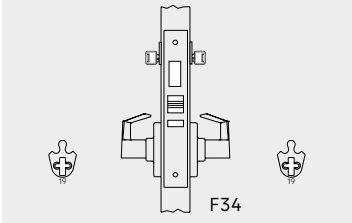
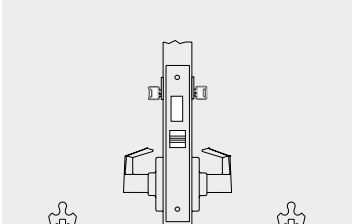
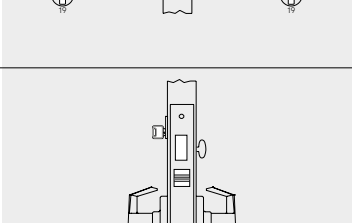
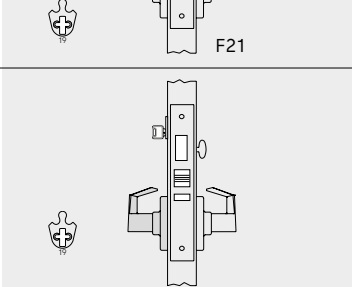

Indicates rigid lever.

CAUTION: Double cylinder locks on residences and any door in any structure which is used for egress are a life safety hazard in times of emergency and their use is not recommended. Installation should be in accordance with existing local codes only.

Function	Series	Outside/Inside	Description
Cylinder x Cylinder Dead Bolt (only)	M1962	 F16	<ul style="list-style-type: none"> • Dead bolt operated by key either side.
Classroom Dead Bolt (only)	M1963	 F29	<ul style="list-style-type: none"> • Dead bolt operated by key outside. • Turn inside retracts but does not project dead bolt.
Storeroom with Dead Bolt	M1966	 F14	<ul style="list-style-type: none"> • Latch bolt operated by trim either side. • Dead bolt operated by key either side.
Intruder Dead Bolt	M1967	 F34	<ul style="list-style-type: none"> • Latch bolt operated by trim either side, except when outside trim locked by key either side. • Dead bolt operated by key either side. • Inside trim operates both bolts and unlocks outside trim. • Latch bolt deadlocked when dead bolt thrown.
Intruder w/Dead Bolt	M1968	 F34	<ul style="list-style-type: none"> • Latch operated by turning key in outside cylinder, rotating the outside lever handle when the deadbolt is retracted or by rotating the inside lever handle • Deadbolt is operated by turning the key in the outside cylinder or inside cylinder • Outside lever handle locked by extending the deadbolt by turning the key in the inside or outside cylinder • Rotating the inside lever retracts the deadbolt and latch simultaneously • Inside lever handle is always unlocked
Dormitory with Dead Bolt	M1973	 F21	<ul style="list-style-type: none"> • Latch bolt operated by trim either side. • Dead bolt operated by key outside or by turn inside.
Storeroom with Dead Bolt	M1980	 F21	<ul style="list-style-type: none"> • Latch bolt operated by key outside or by trim inside. • Outside trim always rigid. • Dead bolt projected by key outside or by turn inside. • Inside trim operates both bolts simultaneously. • Auxiliary latch or dead bolt deadlocks latch bolt.

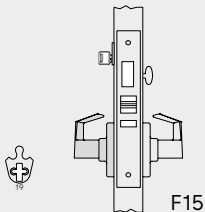
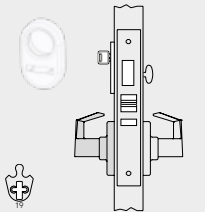
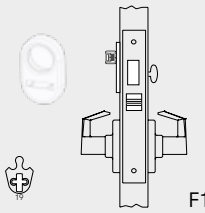
 Indicates rigid lever.

Function	Series	Outside/Inside	Description
Faculty Restroom/ Hotel with Deadbolt	M1985	 F15	<ul style="list-style-type: none"> • Latch bolt operated by key outside or trim inside. • Outside trim always rigid. • Latch bolt retracted by key outside. • Deadbolt projected by turn inside, and all keys, except emergency key, are shut out. • Inside trim operates both bolts simultaneously. • Auxiliary latch or deadbolt deadlocks latch bolt.
Faculty Restroom/Hotel with Deadbolt and Indicator (Sectional trim only)	M1986	 F15	<ul style="list-style-type: none"> • Latch bolt operated by key outside or trim inside. • Outside trim always rigid. • Latch bolt retracted by key outside. • Deadbolt projected by turn inside, and all keys, except emergency key, are shut out. • Inside trim operates both bolts simultaneously. • Auxiliary latch or deadbolt deadlocks latch bolt. • Indicator message reads OCCUPIED/VACANT.
Privacy with Deadbolt and Indicator (Sectional trim only)	M1996	 F13	<ul style="list-style-type: none"> • Latch bolt operated by trim either side. • Deadbolt operated by key outside (key required in the event of an emergency) or by turn inside. • Projecting deadbolt locks outside trim, deadlocks latch, and displays OCCUPIED message. • Inside trim operates both bolts simultaneously and unlocks outside trim.

 Indicates rigid lever.

Electromechanical options

Electromechanical Functions

- Electrically locked (fail safe).
- Electrically unlocked (fail secure).

Electrical Requirements for Solenoid Functions

Voltage: 24 VDC regulated, filtered.
Current: 0.21 A. UL and CUL listed for use on fire doors.

- Solenoids are rated for continuous duty.
- Repeated operation at voltage exceeding +/-10% is not recommended.

Monitoring Options

Single pole double throw (SPDT) type C switches, rated 2 A @ 30 VDC

RX — Request-to-exit signaling switch.

- A single switch mounted internally in the lock body that provides independent monitoring of inside lever rotation.
- Available on the following functions: M1080EL, M1080EU, M1082EL, M1082EU.

When ordering specify **RX**.

Example: M1010EURX.

QC- Quick Connect.

When ordering specify **QC**.

Example: M1080EUQC

LM — Latch bolt monitor.

- A single switch mounted internally in the lock body signaling latch bolt position.
- Available on the following functions: M1080EL, M1080EU, M1082EL, M1082EU.

When ordering specify **LM**.

Example: M1080EULM.

RX and LM and QC monitoring available on the following functions: M1080EL, M1080EU.

When ordering specify **RX LM**.

Example: M1080EURXLM.

NOTE:

Opening the lock case or the replacement of the solenoid or switches in the field by non-authorized personnel voids UL label and lock warranty.

Lock options

Lever options – Premium Tactile Warning (Knurling)

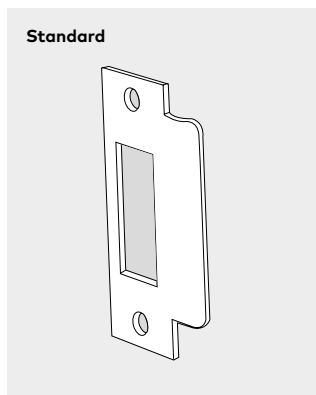

5006 — ANSI 1-1/4" x 4-7/8" curved lip strike. 1-1/4" lip length. Default non-handed strike for all M1000 Series lock functions. Strikes are available in the following lip lengths: 7/8", 1-1/2", 1-3/4", 2", and 2-1/4". Includes dust box.

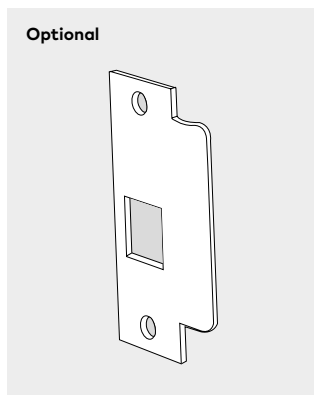

5007 — ANSI 1-1/4" x 4-7/8" curved lip strike. 1-1/4" lip length. Optional handed strike for the following non-dead bolt functions: M1010, 1041, 1043, 1047, 1050, 1053, 1056, 1070, 1080, 1080EL/ EU, 1060, 1071, 1082, 1082EL/EU. Includes dust box.

NOTE: Not approved for use on UL fire listed applications.

Adhesive strip available on levers.



Occupancy Indicators

Occupancy indicators for M1000 Series with sectional trim are available for dead bolt applications where door status confirmation is required. Available keyed or non-keyed and can be used outside, inside, or on both sides of door. Emergency override on non-keyed available.



79019 — Indicator for rose trim used with cylinder, reading OCCUPIED/VACANT.



79020 — Indicator for rose trim used without cylinder, emergency access, reading OCCUPIED/VACANT



79022 — Indicator with cointurn for rose trim used without cylinder, reading OCCUPIED/VACANT.

NOTES:

- Occupancy indicators are for use on 1-3/4"–2-1/8" thick doors. Consult factory for thicker door applications.
- Indicators will work on the following functions 1056, 1940, 1942, 1953, 1956, 1957, 1959, 1960, 1961, 1962, 1966, 1967, 1968, 1973, 1980, 1985.
- Specify Finish. Example: 79019 626.

Our Sustainability Commitment

We are committed to foster a sustainable development along our entire value chain in line with our economic, environmental and social responsibilities toward current and future generations. Sustainability at product level is an important, future-oriented approach in the field of construction. In order to give quantified disclosures of a product's environmental impact through its entire life cycle, dormakaba provides Environmental Product Declarations (EPD), based on holistic life cycle assessments.

www.dormakaba.com/sustainability



Our offering

Access Automation Solutions

Entrance Automation
Entrance Security



Access Control Solutions

Electronic Access & Data
Escape and Rescue Systems
Lodging Systems



Access Hardware Solutions

Door Closers
Architectural Hardware
Mechanical Key Systems



Services

Technical Support
Installation and commissioning
Maintenance and Repair



Key & Wall Solutions

Key Systems
Movable / Sliding Walls



Safe Locks

Electronic Safe Locks
Mechanical Safe Locks
Boltworks and Accessories



Glass systems

Manual door systems
Glass fittings
Horizontal Sliding Walls



KAA1623, EN, 01/2024
Subject to change without notice

dormakaba USA, Inc.
6161 E. 75th St.
Indianapolis, IN 46250
800.523.8483
www.dormakaba.us



dormakaba.com