

"SOUND" DECISIONS WITH RESPECT TO INSULATING OPERABLE PARTITIONS



In virtually every environment, sound insulation is a key factor. Selection of the right operable partition is of major importance in noise abatement applications. The decision as to which operable partition system to use needs to be based not

only on the room design, the configuration of the application and the wall functions, but also on the individual insulation properties of the movable wall in question. Combined with the adjoining construction elements, the right partition system will help to create an outstanding sound-protected ambience.

One of the decisive criteria is how the sound level in adjoining rooms can be reduced.

- What sound insulation value is necessary?
- How can this be achieved?
- What partition system is most suited to meeting the requirements?
- Which constructional elements have to be taken into account in the project?

Estimation of future sound level

Selection of an effective system capable of attenuating sound and the noises occurring in a certain environment depends in the first instance on the types of sound and the noise levels involved.

An increase or decrease in the sound level of 10 dB is perceived by the human ear as a doubling or halving of the sound volume (logarithmic measure!).

If the intensity of a sound source is doubled, the audible sound is perceived as only being slightly louder. In order to generate twice the sound level, approximately 16 sources generating the same sound level would be necessary.

Two times 80 equals 83, not 160



The adjacent table showing typical sound pressure levels provides an overview of the various types of every-day noise encountered. Measurement is on a scale of 0 decibels (dB) – the lowest audibility threshold) up to 120 dB (pain threshold) and beyond. This table is an initial, practical aid for estimating the individual sound level of an application.

Level dB (A)		Conventional noise equivalent
Short periods of exposure can lead to hearing impairment	140	Jet take-off
Schmerzgrenze	120	Pneumatic hammer
Ohrenbetäubender Lärm	110	Sirens
	100	Storm Hard-rock band Pneumatic riveter
Sehr laut	90	Machine shop Boiler plant
Too loud for telephone calls	80	Loud machinery 25-piece orchestra
Loud	70	Printing press Kitchen equipment
	60	Sports car (approx. 80 km/h) 9-piece orchestra
Medium volume	50	Speech Norma factory noise Normal radio noise Normal conversation
	40	Normal office noise Quiet radio
Quiet	30	Normal living room noise
	20	Private office Normal auditorium
Very quiet	10	Leise Unterhaltung Filmproduktion
Lowest audible threshold	0	Whispering Sound-proofed room Human respiration

How much sound is transmitted from one room into an adjacent room?

The industry-wide standard for measuring the sound insulation afforded by operable partitions is based on measurements in decibels (dB). The partitions in question are exposed in the laboratory to sound of various frequencies (100-4000 Hz) in order to determine the reduction in the sound level from one wall/partition side to the other.

In performing measurements between two rooms, the sound reduction value "R" derived from the sound level differential "D" (difference between source noise in transmission room L1 and sound level receiving room L2), the absorption area "A" of the receiving room and the test area "S" of the construction element.

$$R = L_1 - L_2 + 10 \lg (S/A) \text{ dB}$$

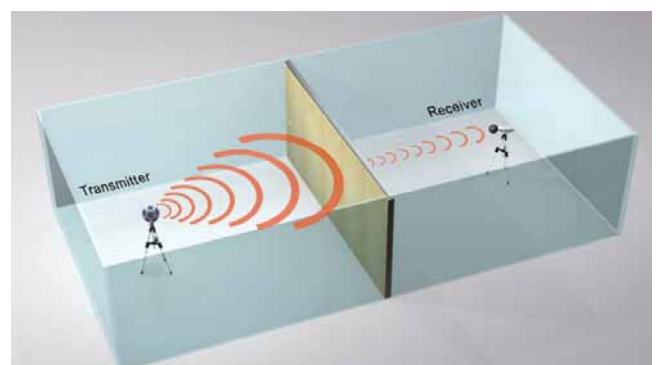

"SOUND" DECISIONS WITH RESPECT TO INSULATING OPERABLE PARTITIONS

The testing of our operable partitions in their fully functional condition is performed in accordance with EN 20140-3 in laboratory facilities of accredited test and approval institutes. The procedures take the form of type approval tests under standardised conditions in a test facility to EN ISO 140-3. The walls and ceilings of a test facility are comprised of concrete or heavy masonry for suppression of flanking transmission.

If, for example, 70 dB is measured on one side of the partition and only 30 dB on the other, the sound reduction value is 40 dB. This means that the sound level is reduced four-fold. However, ambient noise occurs in a wide frequency range. Consequently, the dB values are determined as individual indices for specific frequencies in order to arrive at the sound reduction value for a partition.

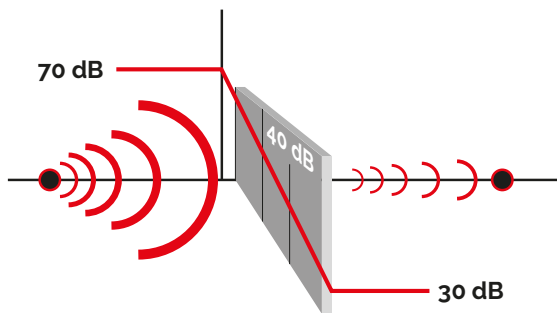

The sound reduction/sound insulation ultimately achieved in a specific building is, moreover, governed by a complex interrelationship of additional building-related factors:

- Transmission via flanking sound paths such as air shafts, cable ducts, etc.
- Flanking components with no acoustic break, such as a continuous screed floor covering
- The sound insulation quality of the flanking components and doors and windows in the adjoining walls
- Quality of the structural connection between the components flanking the partition, such as light-weight walls

Meaning of various common sound reduction values

R	General value for the reduction in air-borne sound achieved through the insulating effect of a construction element.
R _w	Weighted sound reduction index. Single value calculated from several measurements taken using noise sources of various frequencies.
R _{w,P}	Weighted sound reduction index achieved in the test condition under standardised conditions. The manufacturer of the construction product may cite this value only!
R'	("R stroke" or "R apostrophe"): Sound reduction index after taking into account the sound transmission caused by flanking elements such as floors, ceilings and fixed walls
R' _{w,B}	Sound reduction index measured in the building inclusive of sound transmission caused by flanking components.

Evaluation of the measured sound reduction index.

In order to evaluate the attenuation of frequency-dependent air-borne and foot-fall sound, the measured sound reduction values are entered together with a reference curve in a frequency diagram. In Germany, for example, the reference curve is stipulated in DIN 4109 to facilitate an objective analysis and has the idealised configuration of the sound reduction index of a 25 cm thick solid brick wall. For the acoustic analysis, a so-called weighted sound reduction index is determined in the test laboratory for frequency bands from 100 to 4000 Hz representing the range most audible to the human ear. This is done on the basis of a displaced reference curve. For this, the two curved diagrams are superimposed and the point of intersection of the displaced reference curve at 500 Hz constitutes the **weighted sound reduction index R_w**.

f (Hz)	R (dB)
100	32.4
125	32.6
160	32.7
200	35.7
250	39.3
315	41.7
400	45.2
500	48.0
630	51.1
800	51.7
1000	51.6
1250	53.0
1600	52.3
2000	51.4
2500	52.6
3150	52.8
4000	53.8
5000	56.7

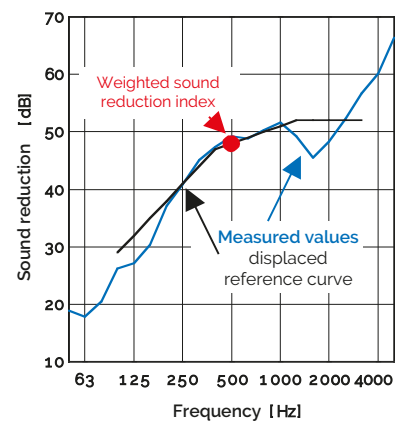

dB values measured different frequency bands

Diagram for the weighted sound reduction index in R_w

Calculation of the weighted sound reduction index and the so-called spectrum adaptation terms is performed in accordance with EN ISO 717-1.

Ceiling, floor, fixtures, fittings and walls must all be taken into account in order to maximise acoustic performance.

Given the fact that an operable partition frequently only accounts for around 10% of all the surface areas present in a room, it becomes immediately clear what influence the floor, ceiling, fixed walls and fixtures and fittings have on effective sound attenuation achieved in a room. This combination of effects is particularly important when it comes to analysing the noise transmitted to "separate" rooms.

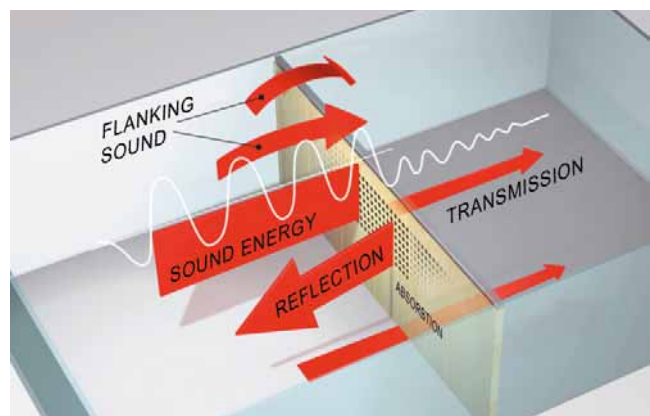

Sound energy which impinges on the partition passes through to the other side of that partition in a process known as sound transmission. That portion which does not pass through the partition and which is instead directed back into the room is termed reflected sound. The sound reduction is the difference between the sound level in the source room and the sound level in the adjacent room. If a reduction is achieved in the source room as a result of, for example, an acoustic surface, this is termed sound absorption.

Sound transmission between two rooms occurs in actual buildings not just via the separating component but also, and in particular, via flanking elements and adjacent pathways. Even when a sound-insulating partition has been correctly installed, it must be remembered that sound can still propagate via these so-called flanking pathways within the building.

If the partitions and the remaining building components are not properly matched and fitted, a significant negative effect on the sound insulating properties of the partition can arise. An operable partition can also only deliver the specified performance if it is correctly incorporated in correspondingly prepared rooms. As a result of poorly or incorrectly installation, "leaks" can occur around the periphery of the partition and between its individual elements. At the same time, airborne sound can pass through to the next room under, over and to the side of the partition via adjacent doors, grilles, air ducts, ceiling cavities, floors and walls.

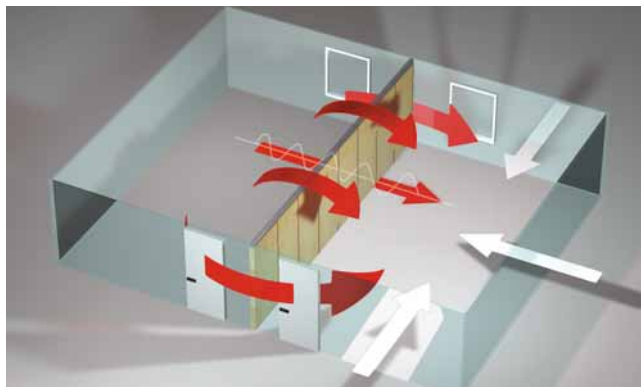

Optimum sound insulation in practice

The best sound insulation performance is obtained from an operable partition by considering not just the sound reduction effect of the movable wall itself but also the sound absorbency of the materials and objects located in the room. In addition, it is particularly important that the flanking sound paths around, below and above the partition are appropriately sealed.

The flanking sound paths can be frequently shut off or at least reduced by provision of a baffle or a means of attenuation at the most important locations. However, partitions are often connected to a light-weight wall or a poorly insulated box encasement around a pipe. It may also be that the partition cannot be directly secured to the masonry because window sills or radiators are barring the way, rendering some form of compensatory element necessary which, as a hollow body, then becomes a sound bridge.

Via the track rail

As a result of the presence of cavities and air gaps above a partition, noise can penetrate via the ceiling from one room to another. This problem can be eliminated by installing a further sound protection means (baffle) above the partition, the sound reduction index of which should be greater or equal to that of the partition. However, it is also frequently the case that air ducting (air-conditioning system shafts) passes through such sound barriers into the cavities, resulting in a reduction in the sound insulation value of the baffle installed. Noise then passes through the thin air duct wall from one room to another. Cable ducts, cable trays and similar may produce the same effect.

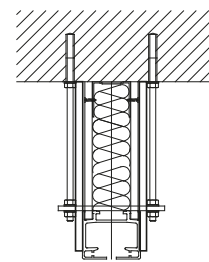
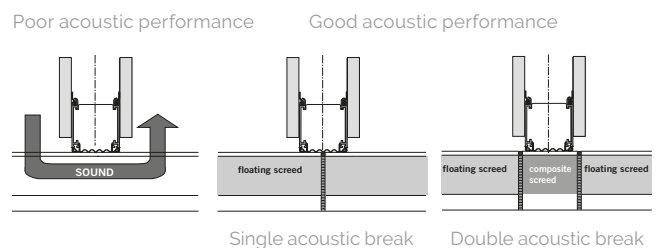

Diagram of a 4-shell baffle

Floor coverings/Cavity floors

In rooms with cavity floors, noise may pass under the partition and, as a result of vibration in the floor, be transferred from one room to another. This problem can be avoided by installing a foot-fall sound barrier (acoustic break) under the partition, the sound reduction index of which should be greater or equal to that of the partition.



Connection between partition and fixed walls

The link between the movable partition and the fixed wall or room divider can be made in various ways. In all cases, however, the joint with the fixed wall must be sealed for air impermeability. Wall rails, dados and other decorative mouldings, and protruding materials must not be allowed to influence the sound absorbing capacity of the system. In partition constructions, the plasterboard panel must always be broken through behind the post in order to avoid flanking sound paths developing through this board and behind the post into the adjacent room.

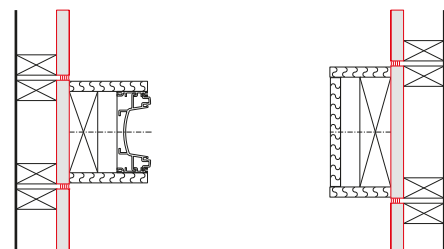

"SOUND" DECISIONS WITH RESPECT TO INSULATING OPERABLE PARTITIONS

Sound absorption

Sound absorption refers to the phenomenon of reducing sound energy within a room. Sound absorption represents the loss of sound energy as it impinges on boundary surfaces, objects or people located in the room.

All construction materials offer a certain degree of sound absorption. A reduced noise level or optimum acoustics for a wide range of different room usages can, however, only be achieved with materials exhibiting a relatively high level of that sound absorption property. The individual sound absorption value of a construction material is specified in the form of an individual absorption index (determined as a function of frequency). The sound absorption index α describes the relationship of the non-reflected sound energy to the sound energy at source. In case of full reflection, $\alpha = 0$; in cases of full absorption, $\alpha = 1$. Hence, at $\alpha = 0.5$, 50% of the sound energy is absorbed and 50% reflected.

In contrast to sound insulation systems in which the material surface must be dense, preventing sound penetration and causing it to be reflected instead, with sound absorption the material surface must be open-pored so that the sound is "muffled" by the material. Here, the mechanical energy is converted by friction into the heat, destroying the sound waves. This process is also referred to as sound energy dissipation.



High reflection without acoustic surface

Low reflection with acoustic surface

Essentially, soft, porous materials (fleece, carpeting) exhibit higher α values than hard materials such as glass, plaster or concrete. The α values of operable partitions relate exclusively to the sound absorbing element surfaces.

So-called acoustic surfaces which are perforated or slotted are used on operable partitions. Such acoustic surfaces create a more pleasant in-room sensation together with a more agreeable ambience. They guarantee reliable sound absorption with an acoustically favourable reverberation time.

Structure of an acoustic surface

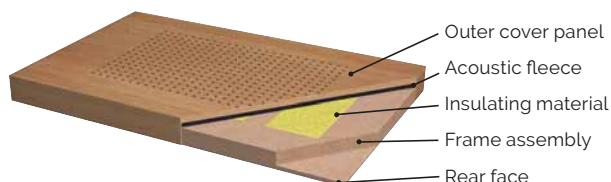

Reverberation time:

Reverberation is an important factor in room acoustics where maximum sound discernibility is desired.

Reverberation can be identified when walking or speaking in a room. An empty room with concrete walls, a plastered ceiling and a hardstone floor is very "echoey" with voice sounds appreciably reverberating. A room with wallpapered walls, a soft fibreboard ceiling and a carpeted floor is, on the other hand, perceived by the speaker to be "hushed". The exact physical unit of measurement for this is that of reverberation time T . This represents the time in seconds in which a sound source suddenly switched off within a room decreases in volume by 60 dB, i.e. the time at which the sound energy is reduced to 1/1,000,000th of the sound energy which prevailed when the source was active. Measurement of the reverberation time is performed with the same devices with which the sound level differential dB is measured, and again as a function of the individual frequency bands.

Sound insulating primer

- The sound-insulating capacity of an operable partition system is indicated by the sound insulation index R_w in dB (decibels) as measured in a test laboratory without flanking components.
- The sound reduction achieved in a specific building is, however, dependent upon the complex interrelationship of many structural and situational factors.
- The ceiling, floor and walls of a room must correspond to the sound-insulating properties of the operable partition system.
- Transmission via flanking sound paths and flanking components may significantly impair the sound-insulating properties of an operable partition. These influences are beyond the control of the partition manufacturer. Consequently, the supplier of such components cannot offer any guarantees as to their sound-insulating performance in their installed condition.
- In practice, however, we can indeed point to many applications in which we have achieved optimum sound reduction values. It is important to achieve technical clarification in advance of the application with respect to the range of sound reduction required for the type of usage of the room concerned. Our advisors have at their disposal empirical values relating to the associated requirements and factors, and these can be readily incorporated at the planning stage.

DORMA Hüppe Raumtrennsysteme GmbH + Co. KG

Industriestraße 5
D-26655 Westerstede/Ocholt

T +49 4409 666 0
F +49 4409 666 489

info-hueppe@dormakaba.com
www.dorma-hueppe.com