

DB100/DB600

Grade 1 & Grade 2

Deadbolts



Deadbolts

The DB100 Grade 1 Heavy-Duty Deadbolt and the DB600 Grade 2 Deadbolt offer increased security, reliability and durability.

Each are manufactured with the finest materials and boasts improved lead times with a broader breadth of functional offerings and finishes while maintaining the aesthetics of preceding portfolios.

dormakabakaba USA quality and environmental management systems in Indianapolis, IN are certified to ISO 9001:2015 and ISO 14001:2015.



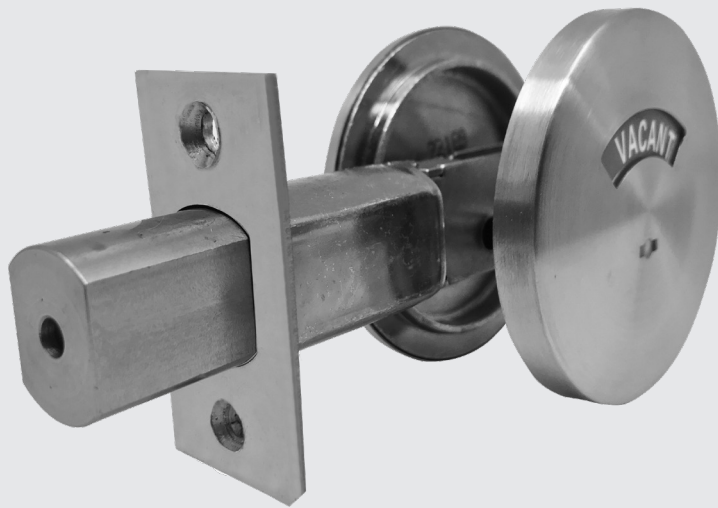

DB100 Series Grade 1 Deadbolt
DB171 – Turn x Occupancy Indicator Shown



DB600 Series Grade 2 Deadbolt
DB660 – Cylinder x Turn Shown

04
DB100 Series
Features

08
DB600 Series
Features

05
How to Order
DB100 Series

09
How to Order
Functions
DB600 Series

06
Keying Options

10
Lock Options

07
Functions
DB100

DB100 Series Deadbolts

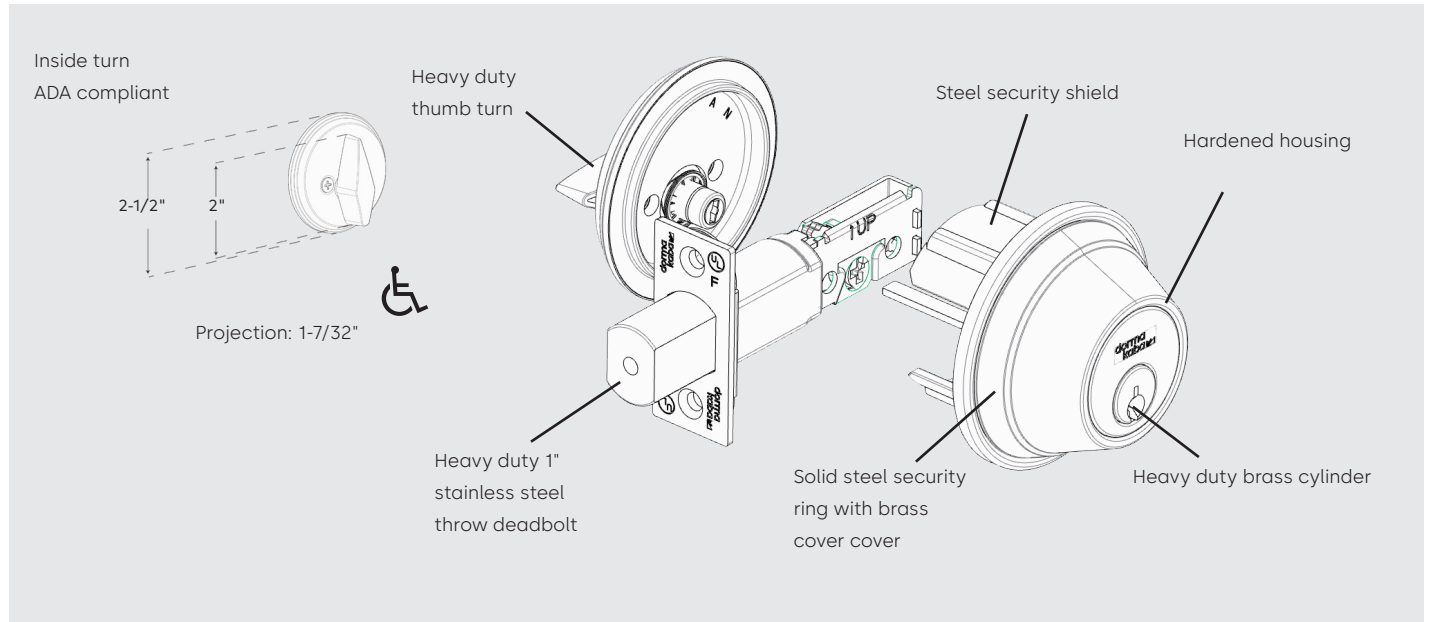

Providing increased security, reliability, and durability.

dormakabakaba offers a choice of rugged deadbolts to provide an added level of protection. The DB100 Series are Grade 1 deadbolts available in both 2-3/8" and 2-3/4" (standard) backsets. The large deadbolt is made from stainless steel with a hardened steel pin/roller A Heavy-Duty brass cylinder in a hardened steel housing surrounded by a solid brass spin ring complete the security package in the door. This is coupled with a solid strike and an additional reinforcing plate with 3" screws for wood jamb installations. All of these features provide an exceptionally strong and secure deadbolt.

Recommended Applications

- Schools and Universities
- Hotels
- Apartments
- Hospitals and Nursing Homes
- Churches
- Municipal Buildings

- Airports
- Retail Complexes
- Offices
- Warehouses

Technical Details

- Hardened steel housing for superior protection against blunt force attack.
- Solid brass spin ring for protection against attack by wrenching and prying.
- High strength steel mounting screws for protection against prying.
- Available in all dormakaba SKC keyways in Small Format Interchangeable Core (SFIC), and standard cylinders. Also available in many Best keyways as well as Schlage C and E, Sargent LA, and many others Consult factory for additional keyways.
- Strike reinforcement with 3" wood screws for wooden jambs provides increased resistance to kick-in attack.

Certification

- ANSI/BHMA A156.36 Grade 1 certified.
- UL listed 3 hour fire rated.
- ADA Compliant ANSI A117.1



Cylinders and Keying

- Unless otherwise specified, cylinders will be provided in Schlage C keyway with two (2) nickel silver keys.
- Optional patented key system available.
- Refer to Price List for full details and options such as master keying, retrofit cylinders and keyways, and small format interchangeable cores.

Warranty

For details, refer to Warranty Statement on our website

Finishes

- 605 Bright Brass
- 606 Satin Brass
- 612 Satin Bronze
- 613 Dark Oxidized Satin Bronze
- 619 Satin Nickel
- 622 Matte Black
- 625 Bright Chrome
- 626 Satin Chrome

Antimicrobial Protected Coating

Specify AM.
(626 finish only)

Special Finish Notes

ANSI/BHMA A156.18 standards describe 613 Dark Oxidized Satin

Bronze finish as a category B finish. B category finishes, “do not match from one alloy or form of material to the next and from one manufacturer to the next.” The 613 finish may vary between manufacturers’ products and models.

In some instances, for customer convenience, the most appropriate BHMA finish symbols are used to indicate similarity of appearance, regardless of base metal or finishing process. Finishes of latches, strikes, cylinders/cores, and visible mounting screws, though similar in appearance, may differ from the finish of the trim.

Finish designations in the 600 numbers are the BHMA (Builders Hardware Manufacturers Association) industry standard.

Door Preparation

2-1/8” diameter mounting hole.

How to order

DB100 Series locks

		Function		Cylinder Type ¹		Latch Bolt ³		Keying Options Field		
	Turn x Turn —	82								
	Turn only —	81								
	Turn x Blank Plate —	80								
	Turn x Occupancy Indicator —	71								
	Cylinder x Classroom —	63								
	Cylinder x Cylinder —	62	D							
	Cylinder x Blank Plate —	61	J							
	Cylinder x Turn —	60	T							
		DB	1	60	D	626		28752	5103	XXXX
Deadbolt —	D									
Product Type		Bright Brass —	605	AM						Strike Options²
		Satin Brass —	606	Antimicrobial Coating³						
		Satin Bronze ⁴ —	612							
		Dark Oxidized Satin Bronze —	613							
		Satin Nickel ⁴ —	619							
		Matte Black ⁴ —	622							
		Bright Chrome ⁴ —	625							
		Satin Chrome —	626							
Product Family										

Heavy-Duty Grade 1 Tubular Deadbolt

Finish

Footnotes:

1. The Less Conventional Cylinder option is not available for the DB100 Series.
2. Example shows default values. Refer to Lock Options section for full details.
3. Available on 626 finish only.
4. Special Order Finish — May require additional lead time.

Keying Options

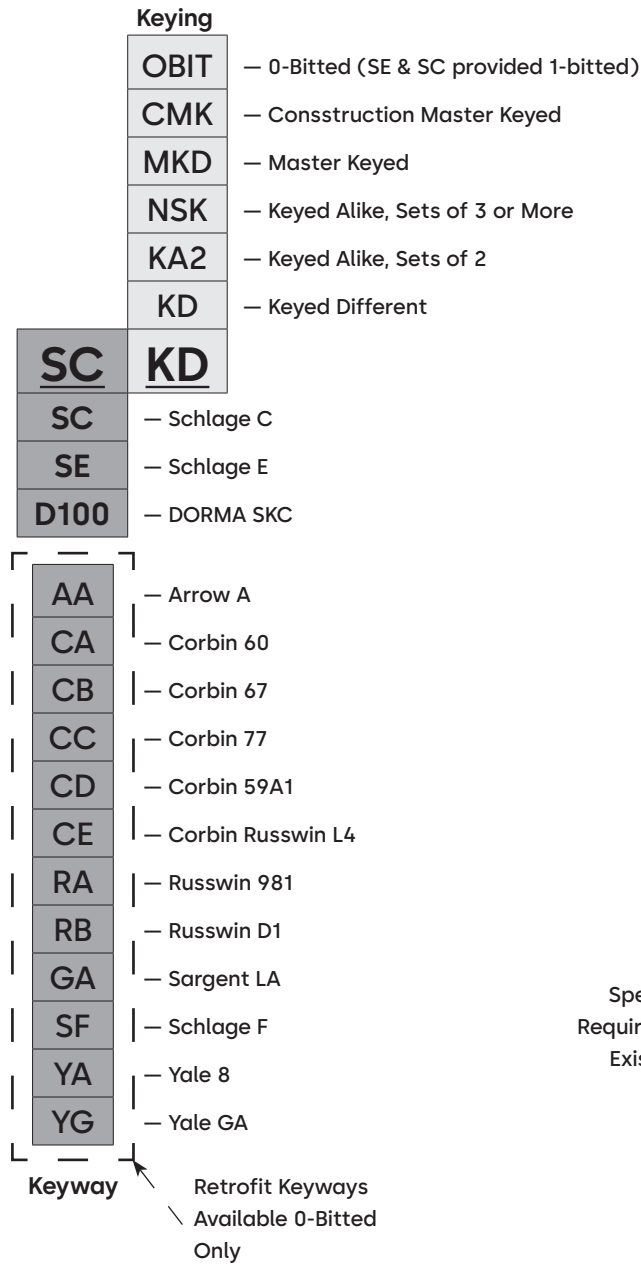

Standard Cylinder Keyways

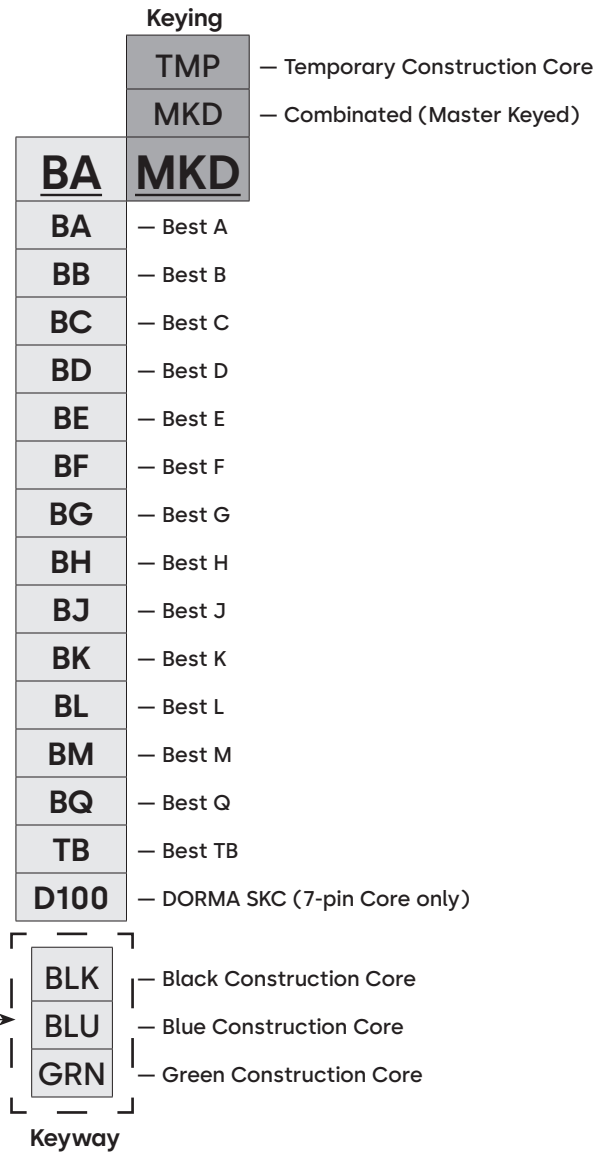

SFIC Keyways

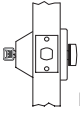
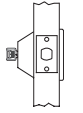
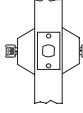
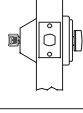

Functions

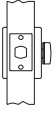
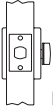
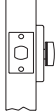
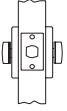
Function	Series	Outside/Inside	Description
Cylinder × Turn	DB160	 E2151	<ul style="list-style-type: none"> • Deadbolt operated by key outside or by turn inside. • Bolt automatically deadlocks when fully thrown.
Cylinder × Blank Plate	DB161	 E2161	<ul style="list-style-type: none"> • Deadbolt operated by key one side. Blank plate on the other side. • Bolt automatically deadlocks when fully thrown.
Cylinder × Cylinder*	DB162	 E2141	<ul style="list-style-type: none"> • Deadbolt operated by key either side. • Bolt automatically deadlocks when fully thrown.
Cylinder × Classroom	DB163	 ONLY E2171	<ul style="list-style-type: none"> • Deadbolt operated by key outside. • Turn retracts deadbolt but does not project it. • Bolt automatically deadlocks when fully thrown.
Turn × Occupancy Indicator	DB171	  E2111	<ul style="list-style-type: none"> • Deadbolt operated by turn inside. • Occupancy indicator on outside reads either VACANT or OCCUPIED in color coding. • Coin turn for emergency access on outside. • Bolt automatically deadlocks when fully thrown.
Turn × Blank Plate	DB180	 E2191	<ul style="list-style-type: none"> • Deadbolt operated by turn inside. Blank plate on other side. • Bolt automatically deadlocks when fully thrown.
Turn Only	DB181		<ul style="list-style-type: none"> • Deadbolt operated by turn inside. No trim on outside. • Bolt automatically deadlocks when fully thrown.
Turn × Turn	DB182		<ul style="list-style-type: none"> • Deadbolt operated by turn either side. • Bolt automatically deadlocks when fully thrown.

* **CAUTION:** Dual cylinder locks can impede egress in emergency situations. Installation should be in accordance with existing codes. DB100 series windstorm listed with C100 cylindrical lock.

DB600 Series Deadbolts

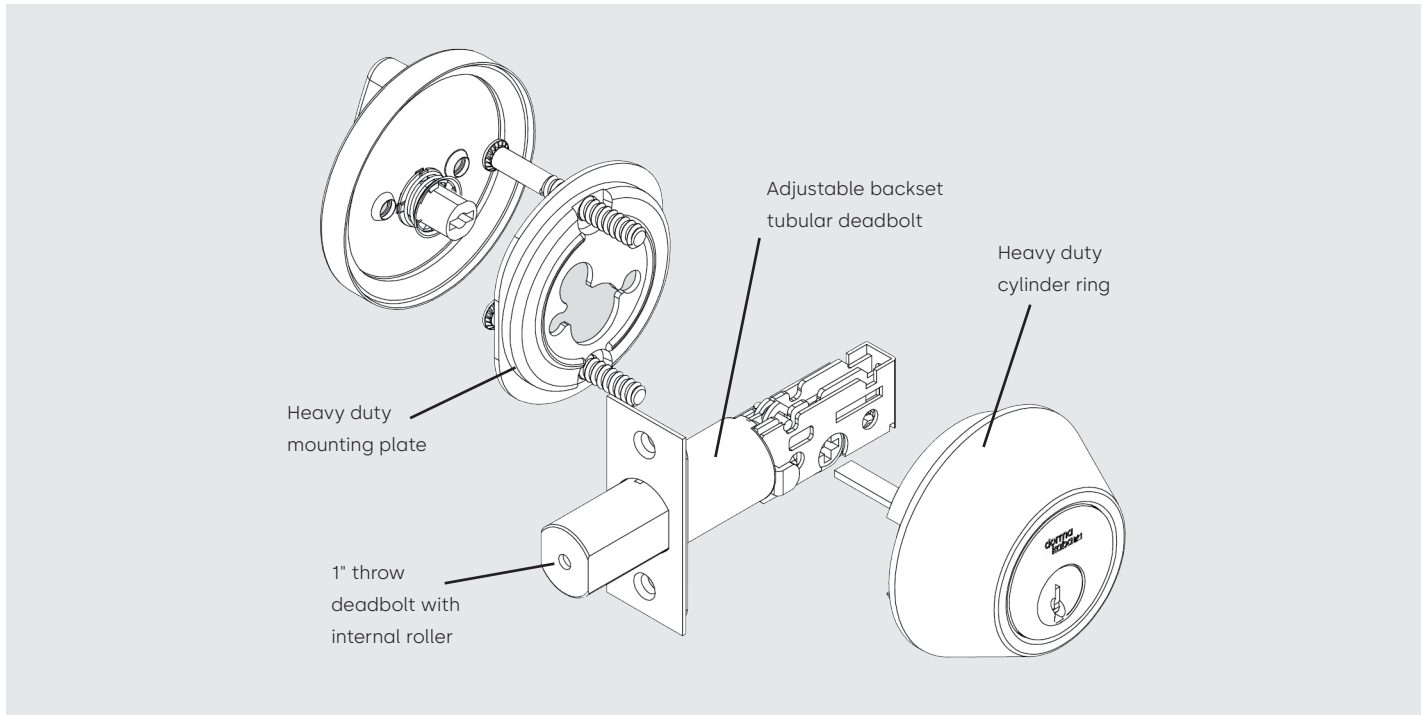

Providing increased security, reliability, and durability.

dormakabakaba offers a choice of rugged deadbolts to provide an added sense of protection. The DB600 Series are Grade 2 deadbolts with an adjustable 2-3/8"– 2-3/4" backset. The 1" throw deadbolt includes a hardened steel roller to prevent sawing through the bolt. The Heavy-Duty cylinders are through-bolted, with reinforced cylinder rings to protect against physical attack. Brass 6-pin cylinders are provided for security and durability. The solid steel strike plate reinforcement with 3" screws protects the door jamb against a kick-in attack.

Recommended Applications

- Apartments
- Municipal Buildings
- Retail Complexes
- Warehouses

Technical Details

- Hardened steel housing for superior protection against blunt force attack.
- Protection against prying and wrenching attack with heavy duty cylinder ring secured with (2) 1/4" - 28 high strength steel mounting bolts in addition to the thumb turn through bolts.
- Available in all dormakaba SKC keyways in Small Format Interchangeable Core (SFIC), Schlage LFIC, and standard cylinders. Also available in many Best keyways as well as Schlage C and E, Sargent LA, and many others. Consult factory for additional keyways.
- Strike reinforcement with 3" wood screws for wooden jambs provides increased resistance to kick-in attack.

Certifications

- ANSI/BHMA A156.36 Grade 2 certified.
- UL listed 3 hour fire rated.

Cylinders and Keying

- Unless otherwise specified, cylinders will be provided in dormakaba standard keyway with two (2) nickel silver keys.
- Optional patented key system available.
- Refer to Price List for full details and options such as master keying, retrofit cylinders and keyways, Schlage LFIC, and small format interchangeable cores.

Warranty

For details, refer to Warranty Statement on our website dormakaba.com/us-en/support



Finishes

- 605 Bright Brass
- 613 Dark Oxidized Satin Bronze
- 619 Satin Nickel
- 626 Satin Chrome
- 629 Bright Stainless
- 630 Satin Stainless

Special Finish Notes

ANSI/BHMA A156.18 standards describe 613 Dark Oxidized Satin

Bronze finish as a category B finish. B category finishes, "do not match from one alloy or form of material to the next and from one manufacturer to the next." The 613 finish may vary between manufacturers' products and models.

In some instances, for customer convenience, the most appropriate BHMA finish symbols are used to indicate similarity of appearance, regardless of

base metal or finishing process. Finishes of latches, strikes, cylinders/cores, and visible mounting screws, though similar in appearance, may differ from the finish of the trim. Finish designations in the 600 numbers are the BHMA (Builders Hardware Manufacturers Association) industry standard.

How to order DB600 Series locks

Cylinder Type⁵

	Function	D	— Conventional Cylinder			
Turn x Blank ⁵ —	80	C	— SFIC (With Core)			
Cylinder x Cylinder —	62	J	— SFIC (Less Core)			
Cylinder x Turn —	60	T	— Temporary SFIC			

Door Thickness⁶

	134	— 1-3/8" — 1-3/4"			
--	------------	-------------------	--	--	--

DB	6	60	D	630	26170	134	5103	XXXX	— See page 6
-----------	----------	-----------	----------	------------	--------------	------------	-------------	-------------	--------------



Product Type →

Product Family →

Finish⁴

Deadbolt —	DB	Bright Brass —	605	26173	— Adj. Drive-In	<p>Keying Options Field</p> <p>Strike Options⁶</p>
		Dark Oxidized Satin Bronze —	613	26171	— Adj. 1" RC	
		Satin Nickel ² —	619	26170	— Adj. 1" SQ with Filler	
		Satin Chrome —	626	Latch Bolt³		
		Bright Stainless ³ —	629			
		Satin Stainless ³ —	630			

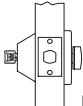
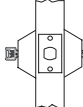
Functions

Function	Series	Outside/Inside	Description
Cylinder x Turn	D660	 E2152	<ul style="list-style-type: none"> • Deadbolt operated by key outside or by turn inside. • Bolt automatically deadlocks with fully thrown
Cylinder x Cylinder	DB662	 E2142	<ul style="list-style-type: none"> • Deadbolt operated by key either side. • Bolt automatically deadlocks with fully thrown
Turn x Blank Plate	DB680	 	<ul style="list-style-type: none"> • Deadbolt operated by turn inside. Blank plate on other side. • Bolt automatically deadlocks when fully thrown.

DB100/DB600 Lock Options

Strikes

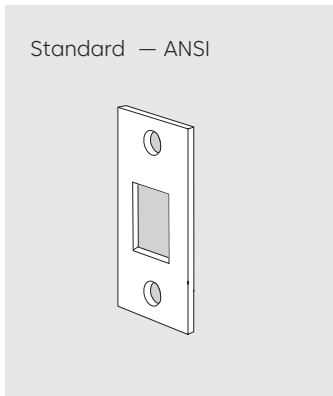

5103 — 1-1/8" x 2-3/4" strike. No lip. Standard for DB100/DB600 Series.

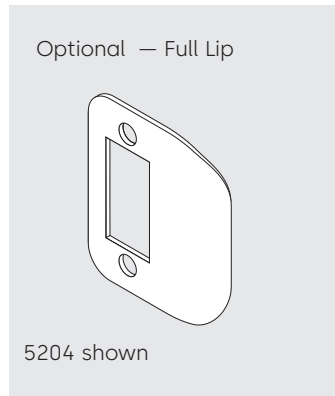

5203 — Square corner 1-5/8" x 2-1/4" full lip strike with deadbolt cutout. 1-1/8" lip length Optional for DB100/DB600 Series.

5204 - Radius corner 1-5/8" x 2-1/4" full lip deadbolt. 1-1/8" lip length. Optional for DB600 series.

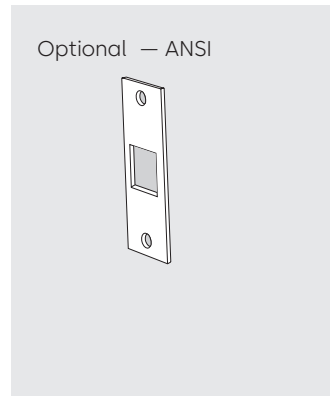

5004 — 1-1/4" x 4-7/8" ANSI strike with deadbolt cutout. No lip. Optional for DB100/DB600 Series.

Latch Bolt

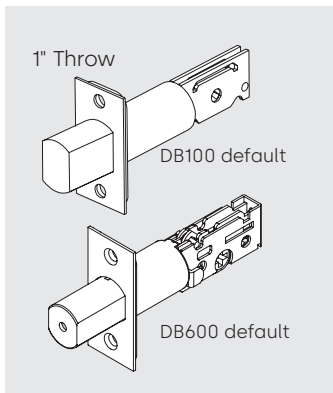

28752 — 2-3/4" backset with 2-1/4" face plate, 1" throw deadbolt Standard for DB100 Series.

28652 — 2-3/8" backset with 2-1/4" face plate, 1" throw deadbolt with 2-3/8" backset. Optional for DB100 Series.

26170 — Square corner 1" x 2-1/4" front, 1" diameter, 1" throw deadbolt with 2-3/8"-2-3/4" adjustable backset. 1-1/8" filler plate included. Standard for DB600 Series.

26171 — 1/4" radiused corner 1" x 2-1/4" front, 1" diameter, 1" throw deadbolt with 2-3/8"-2-3/4" adjustable backset. Optional for DB600 Series.

26173 — Drive in 1" diameter, 1" throw deadbolt with 2-3/8"-2-3/4" adjustable backset. Optional for DB600 Series.

KAA1559_08-23
Subject to change without notice



dormakaba.com

dormakabakaba USA, Inc
6161 E. 75th Street
Indianapolis, IN 46250
Tel: 800 523 8483

dormakabakaba Canada Inc
7301 Decarie Blvd
Montreal, QC H4P 2G7
888 539 7226