

WN 056381 45532
09/08

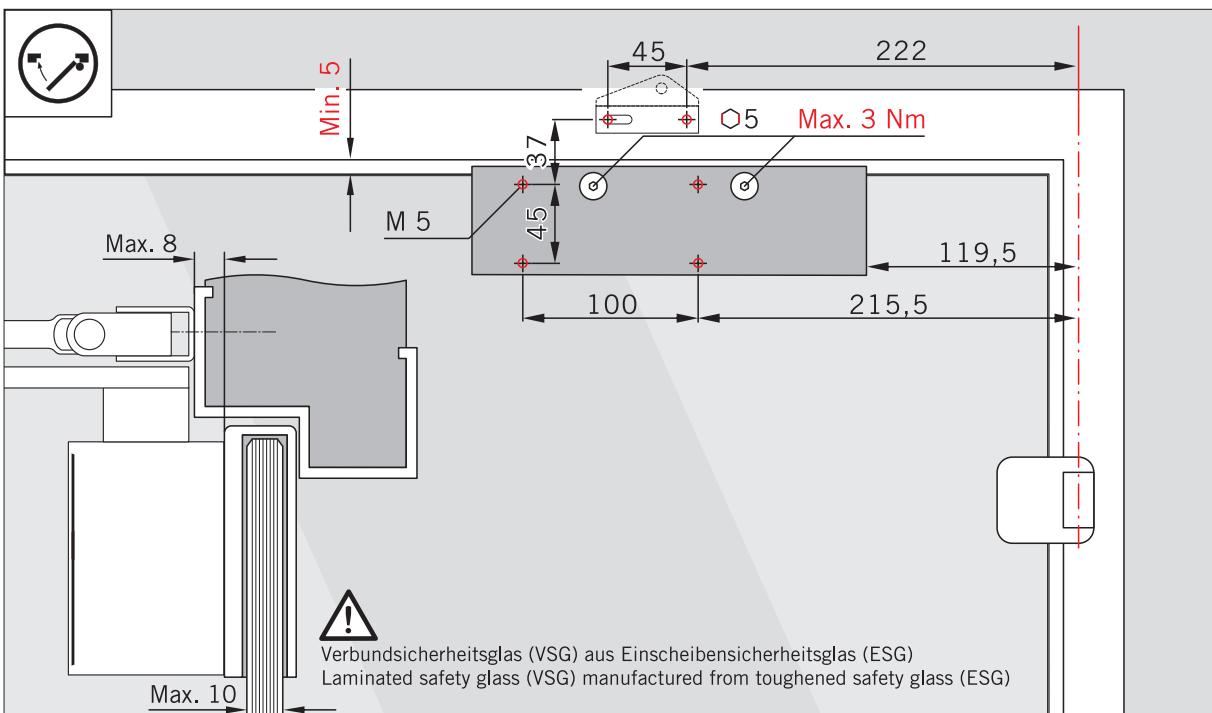
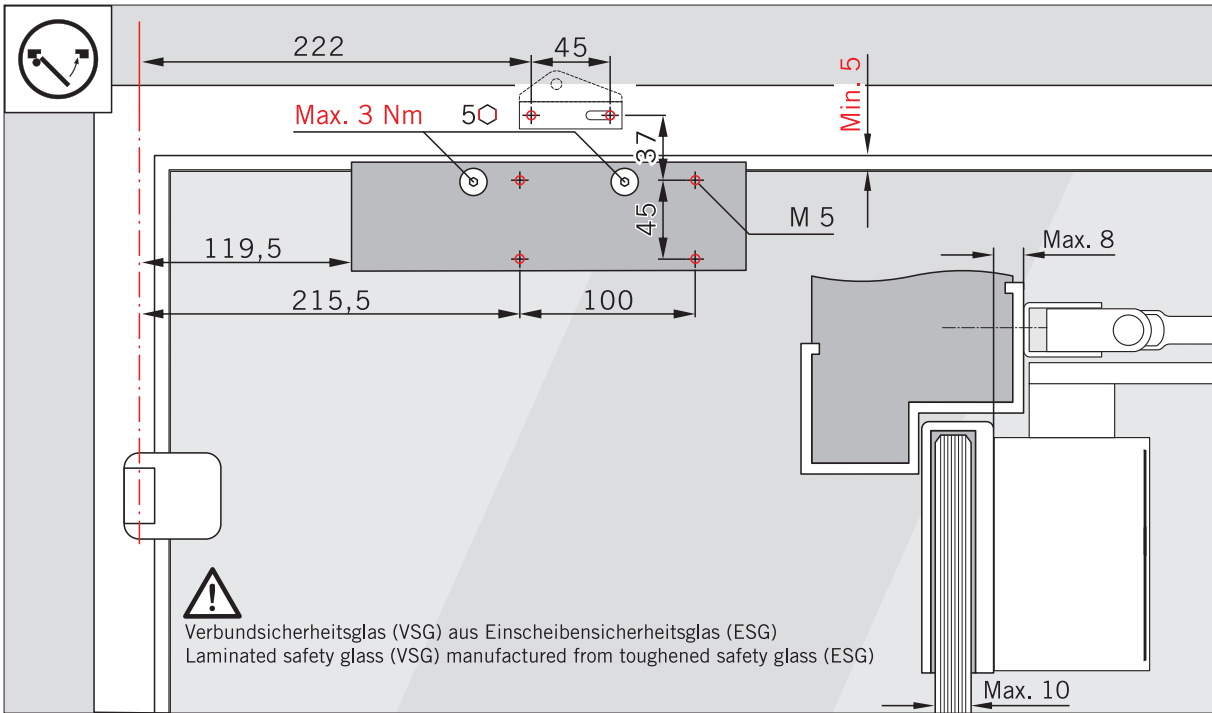
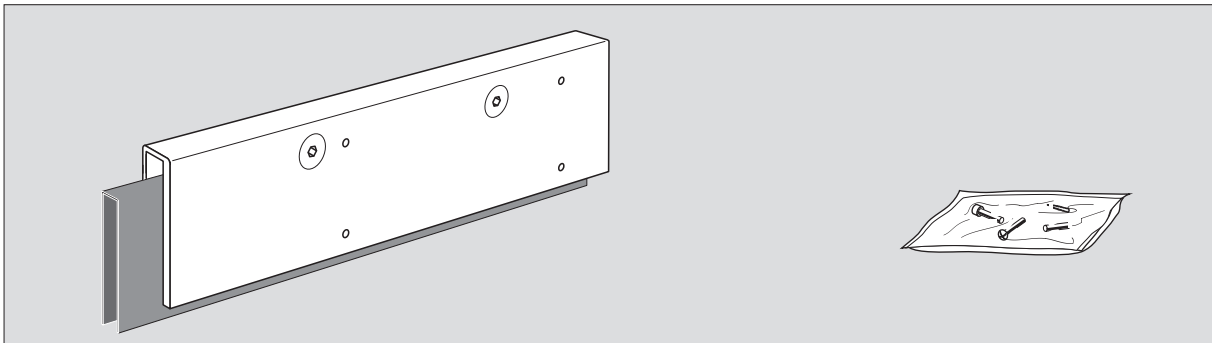

Änderungen vorbehalten
Subject to change without notice