





ED22M EXIT DEVICE INSTALLATION TEMPLATE - THRU FIXING BOLTS (No external trim)

RIGHT HAND INSTALLATION

EXTERNAL
DRILL 2 x Ø9mm HOLES
FOR THRU FIX BOLTS.
DRILL FROM BOTH SIDES OF
TO PREVENT DAMAGE.
Note: Through fixing bolts
required for Fire rated doors.

REQUIRED FIXINGS			
IMAGE	ID	QTY	DESCRIPTION
	A	2	10g x 1" Countersunk timber screw (304SS)
	B	4	M5 x 8mm Panhead metal thread screw (304SS)
	C	2	M6 x 25mm Panhead metal thread screw (304SS)
	D	2	M6 x 25mm Flanged panhead metal thread screw (304SS)
	E	4	M6 x 30mm Internal thread thru fix bolt (304SS)

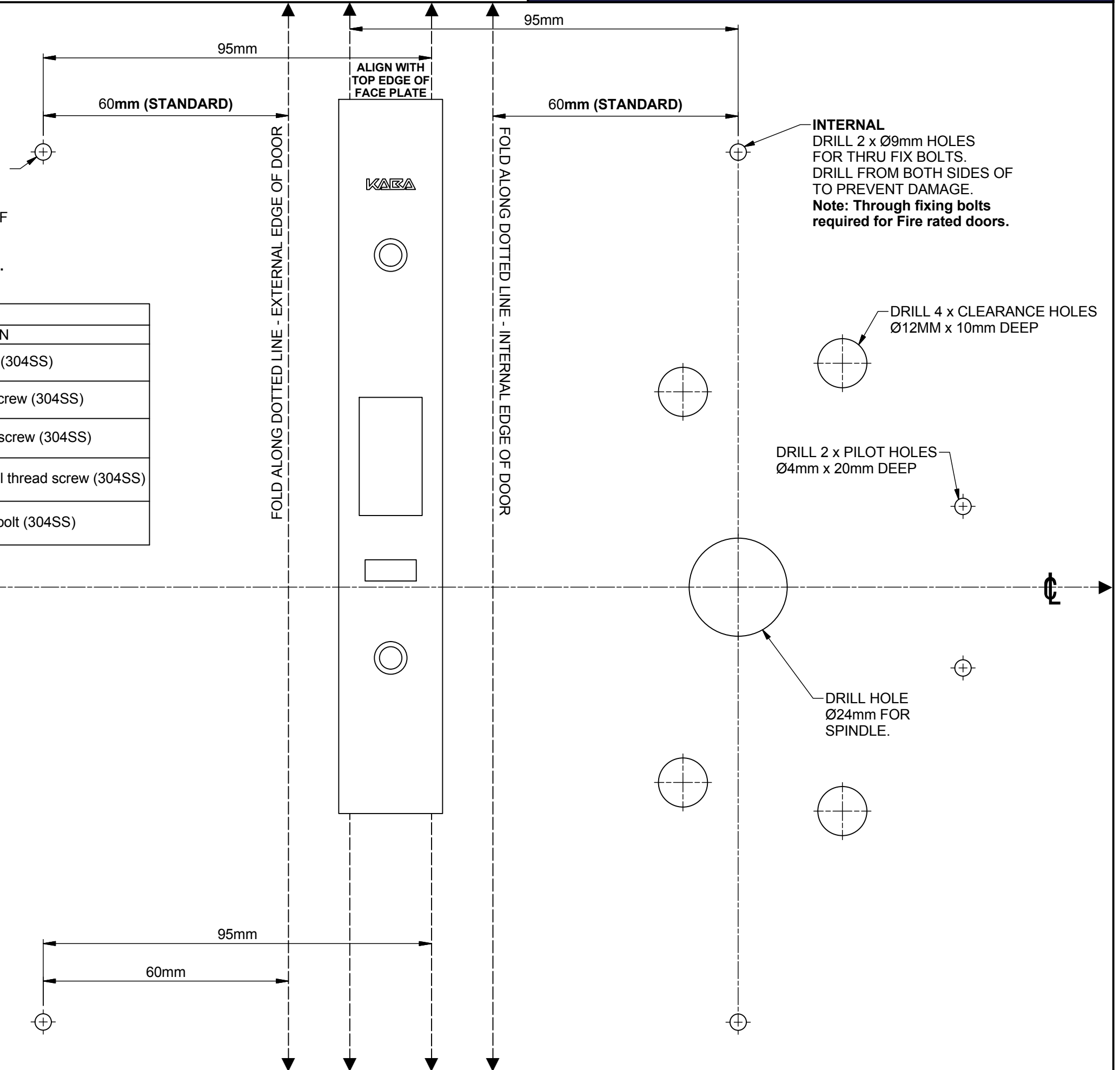

FIXING DETAIL

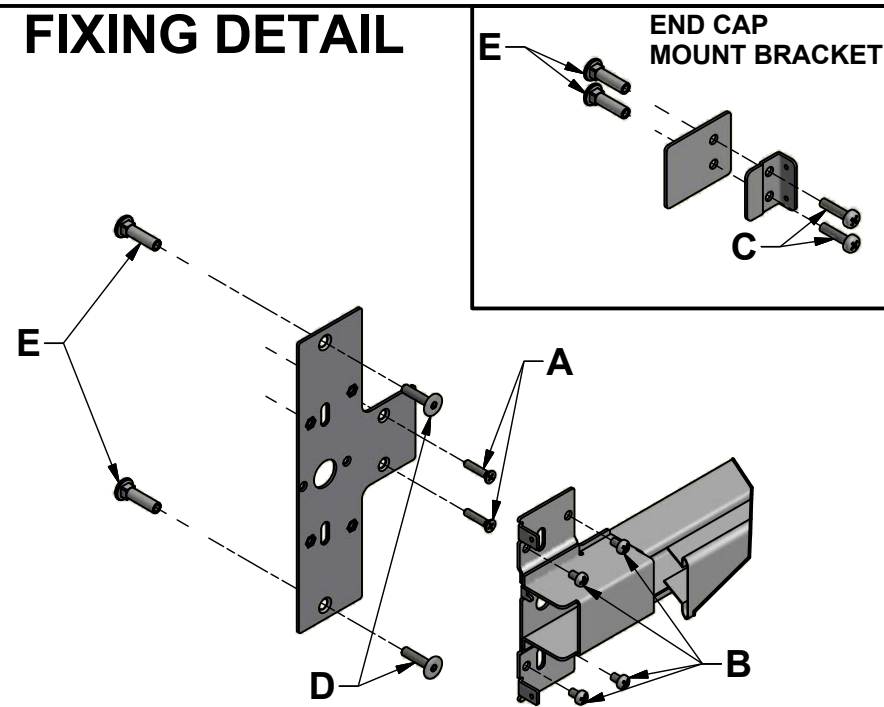

ED22M EXIT DEVICE INSTALLATION TEMPLATE - THROUGH FIXING BOLTS (No external trim)

LEFT HAND INSTALLATION

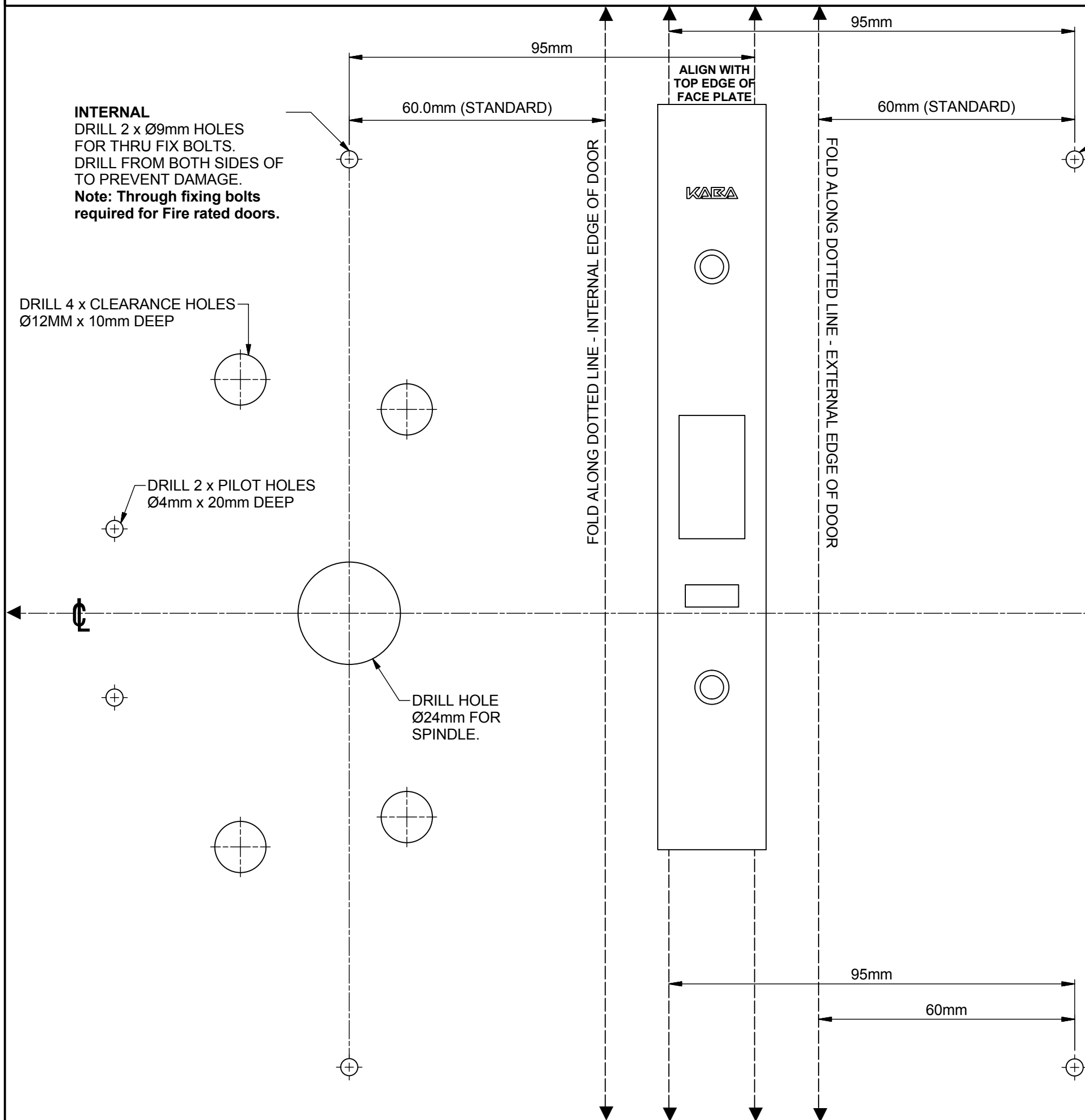

EXTERNAL
DRILL 2 x Ø9mm HOLES FOR THRU FIX BOLTS. DRILL FROM BOTH SIDES OF TO PREVENT DAMAGE.
Note: Through fixing bolts required for Fire rated doors.

REQUIRED FIXINGS			
IMAGE	ID	QTY	DESCRIPTION
	A	2	10g x 1" Countersunk timber screw (304SS)
	B	4	M5 x 8mm Panhead metal thread screw (304SS)
	C	2	M6 x 25mm Panhead metal thread screw (304SS)
	D	2	M6 x 25mm Flanged panhead metal thread screw (304SS)
	E	4	M6 x 30mm Internal thread thru fix bolt (304SS)

