

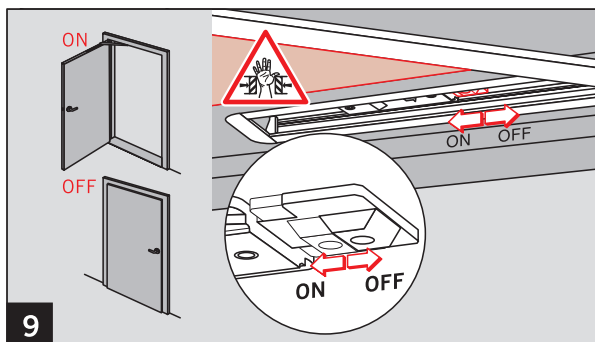

WN 056309 45532  
09/08

Art. Nr.52003600

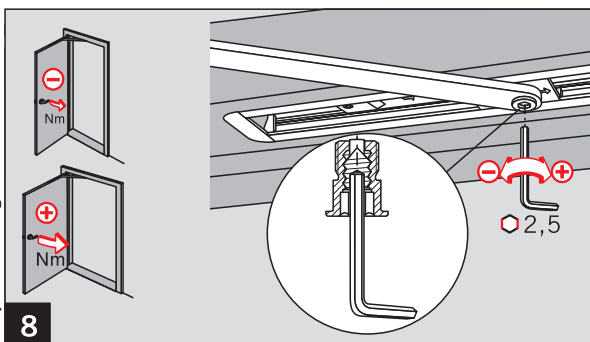
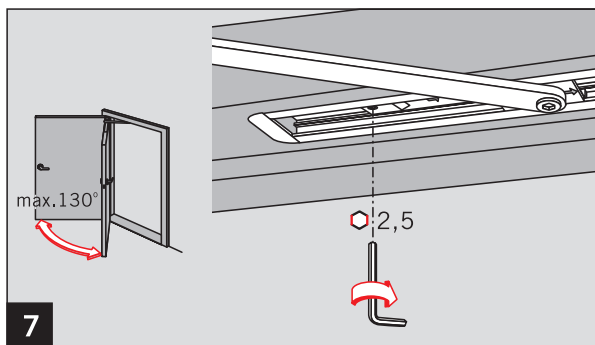
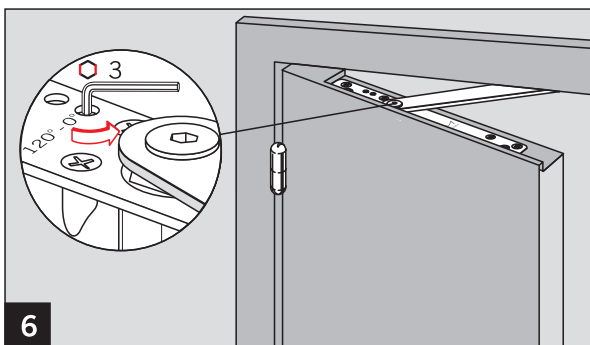
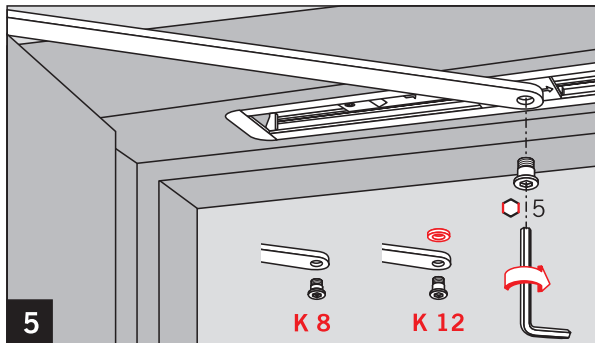
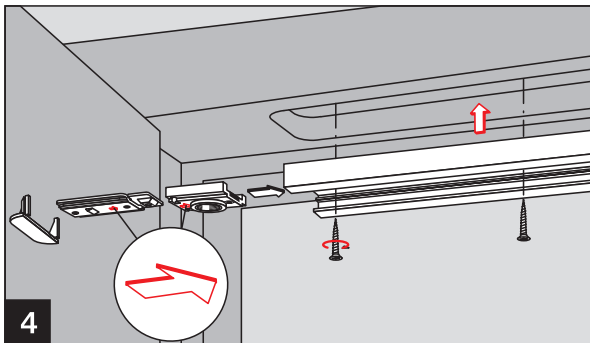
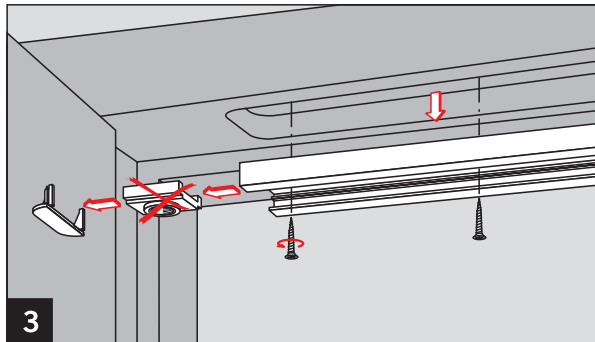
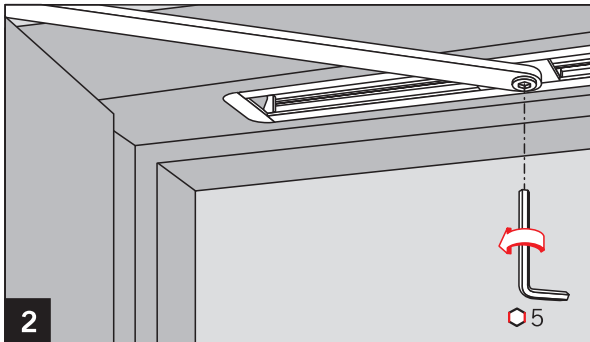
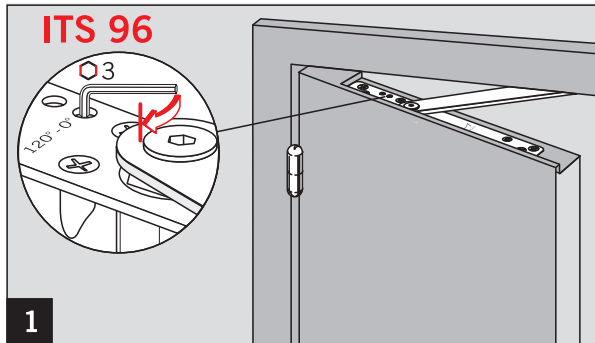
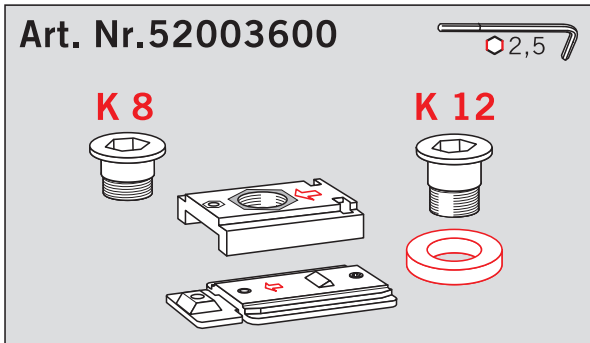

Änderungen vorbehalten  
Subject to change without notice