



dormakaba c-lever pro





Electronic door lock



Advantages at a glance

- Contribution to sustainability: manufactured from durable materials using resource-efficient design, allowing updates and repairs
- The range offers a large variety of combinable products in the same high-quality design
- Fire protection: fulfils requirements for use with smoke and fire doors
- Suitable for outside and security doors (burglary resistant and weather protection)
- Door monitoring with the wireless function
- TouchGo function: your hands are free, the transponder stays in your pocket
- Supports Mobile Access: receive your access right on your smartphone using the dormakaba mobile access app

 Wireless  Mobile Access  TouchGo 

Security and design in one

The electronic door lock c-lever pro offers elegant design and high functionality. Control your access precisely for a nearly unlimited number of users to the right areas at the right times.

Set access rights quickly and change them easily in standalone, remote or online mode.

Assign access rights to smartphones so that users can use their mobile devices as access media to enter.

Smart RFID technology with Bluetooth®

The c-lever pro is part of our consistent standalone portfolio dormakaba evol. It supports the latest RFID technologies and is available with the wireless function: access rights are transmitted from your PC to the door components, wirelessly and in real time. This offers enormous advantages in terms of security, convenience, programming and maintenance.

If you don't want to search for your keys, choose the TouchGo option. The door furniture detects whether the user carries a valid transponder and if this is the case, allows the door to be opened.

Ready for you to use

The c-lever pro is made for outside areas or doors with increased security requirements. It not just offers burglary and fire protection, but also provides solutions for emergency exits and escape routes. High-quality materials meet the demanding requirements in terms of robustness, weather resistance and security.

Its large variety of options makes the c-lever pro suitable for almost every door, both inside and outside. These doors might be the access points to commercial or administration buildings, retirement homes, hospitals, universities or any area worth protecting, like server rooms or storage facilities.

Sophisticated design

You can operate the door easily: whether it's with a card, key fob, a key with RFID or a smartphone – the green signal of the digital lighting unit will appear after presenting your access medium, and you can open the door with the lever handle as usual.

Easy Programming

The c-lever pro is easy to program and suitable both for individual doors and as an element of a large access system. Depending on the selected features and administration software, different programming options are available: For example, access rights may be transmitted either remotely from your PC, with the programming device, via App or with the programming card directly to the electronic door lock.

Essential features

The device software supports all dormakaba system solutions. Main functions:

- Number of access media: - with whitelist up to 4,000
- with CardLink or AoC: practically unlimited
- Internal clock and configurable time profiles
- Time-limited assignment of access rights (validation)
- Saving of last 2,000 door events (can be disabled)

Simple installation

Installation is carried out indoors or in outside areas protected against weather directly on doors made of wood, plastic or metal. Usually, you can continue to use your existing lock. Due to the standalone operation no cables need to be laid.

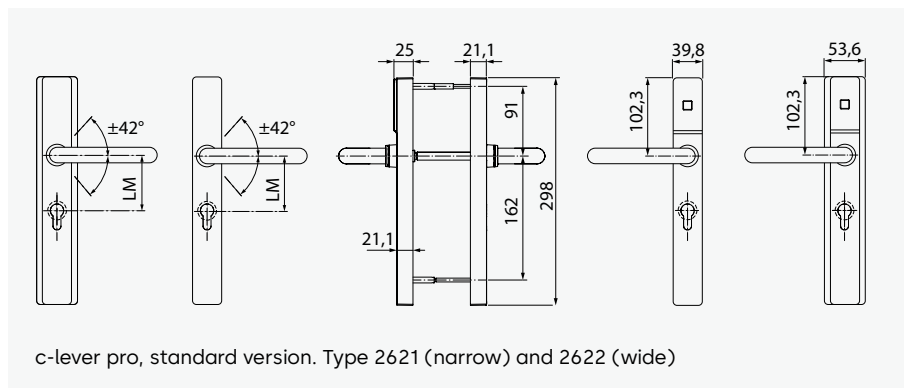

c-lever pro, standard version. Type 2621 (narrow) and 2622 (wide)

Our Sustainability Commitment

dormakaba is committed to foster a sustainable development along our entire value chain. In order to give quantified disclosures of a product's environmental impact and its ecological footprint, dormakaba provides Environmental Product Declarations (EPDs). Download the EPD and read more about our sustainability commitment [here](#) or use the QR code provided.



Note: The range of functions of the product depends on the system environment chosen. Please check the relevant dormakaba catalogue or system description for details and order information.

Subject to technical changes without prior notice. Version 08/2023. © dormakaba.

Technical data

Supported Standards

- LEGIC (advant & prime)
- MIFARE (DESFire & Classic)
- OSS-SO Version 2021-06 (LEGIC advant, MIFARE DESFire)
- NFC - Near Field Communication (with Android smartphones)
- Bluetooth® Low Energy
- IEEE 802.15.4 (with wireless option)

Designs

- Plate: choice of wide or narrow
- Centre distance: 55 - 105 mm (profile-dependent)
- Euro profile, Swiss round profile,
- Scandinavian or Australian oval profile

Versions

- Black or white cover
- Choice of lever handle designs
- Available functions: TouchGo, Wireless and Mobile Access
- Available options: S-module, button function

Dimensions (W x H x D)

- Narrow plate: 39.8 x 298 x 21 mm
- Wide plate: 53.6 x 298 x 21 mm
- Minimum backset 35 mm, 25 mm with offset lever handles

Power supply

- 2 batteries 1.5 V AA L91, FR6 or via the S module
- For TouchGo: together with filter box

Environment/service life

- Temperature: -25 °C to +70 °C
- Protection class: IP55
- Battery life at 20 °C: up to 150,000 cycles or up to 3 years

Certificates

- Building hardware: EN 16867: 4 7 - B 2 4 D 0 0, for version ES1: 4 7 - B 2 4 D 1 2
- Fire/Smoke protection: tested in accordance with EN 1634-1 and -3
- Emergency exit: EN 179 (in combination with appropriate lever handles and locks)
- Panic doors: EN 1125 (in combination with approved panic push bars)

Environmental product declaration: EPD

- Declaration no.: EPD-DOR-20210011-CCA1-EN
- Under ISO 14025 and EN 15804+A2
- Publisher and declaration holder: Institut Bauen und Umwelt e.V.

Any questions? We will be happy to assist you.

dormakaba International Holding AG | Hofwissenstrasse 24 | CH-8153 Rümlang | info.de@dormakaba.com | dormakaba.com