

# TS 92 XEA

## Door closer





Internal pedestrian doorsets within a building require consistency in both form and functionality. The TS 92 XEA door closer supplements the TS 98 XEA system and is for use on internal standard or fire-resistant pedestrian doorsets. Thanks to EASY OPEN Technology for easy door opening, it is comfortable to use and, combined with the TS 98 XEA slide rail door closer system, it ensures ease of access through the entire building.

# The universal door closer for standard doors

Tested according to EN 1154 / CE

**The TS 92 XEA supplements the comprehensive TS 98 XEA slide channel door closer system – excellent quality at a competitive price.**

Thanks to its EASY OPEN technology, the door closer in XEA design allows the same ease of access as the TS 98 XEA slide channel system. Its linear drive and heart-shaped cam ensures a rapidly decreasing opening torque. This allows children, the elderly and disabled people to effortlessly open the doors. During the end phase of the closing cycle, the closing torque increases and the door is reliably closed.

Adjustable power and closing speed makes the TS 92 a user-friendly, standard solution.

The TS 92 XEA is suitable for door widths up to 1,100 mm, for accessible doors and fulfills the requirements of DIN 18040 and DIN SPEC 1104.

The production plant is ISO 9001 certified.

### Advantages for business

- Proven slide channel technology for standard doors
- Low warehousing costs and reduced inventory thanks to the XEA series' standardized slide channels

### Advantages for the technician

- Suitable for both DIN-L and DIN-R doors
- Easy to install and quickly adjustable

### Advantages for the planner

- Excellent value for the money
- Standardized appearance in the entire XEA slide channel program

### Advantages for the user

- Exceptional ease of use and fully controlled closing action
- Optimum closing speed adjustment and reliable closing thanks to two regulating valves

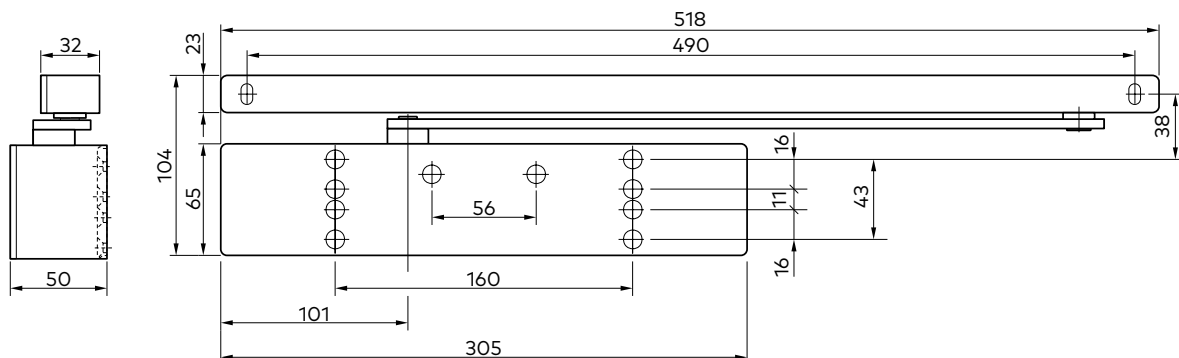

Data and features		TS 92 XEA B/G <sup>1)</sup>
Closing force adjustable	Size	EN 1-4
Standard doors <sup>2)</sup>	≤ 1100 mm	●
External doors, outward opening <sup>2)</sup>		-
Fire and smoke control doors		●
Same design for DIN-L and DIN-R		●
Arm assembly type	Slide channel	●
Closing speed and latching action independently adjustable at two separate valve	180°-15° 15°- 0°	● ●
Cushioned limit stay		○
Backcheck		-
Delayed closing		-
Hold-open		○
Weight in kg		2.2
Dimensions in mm	Length Depth Height	305 50 65
Door closer tested according to EN 1154		●
CE -mark for building products		●
Accessible according to DIN 18040		●

● Yes - No ○ Option

<sup>1)</sup> B = Standard model for pull-side door leaf fixing/  
push-side transom fixing.  
G = Special model for push-side door leaf fixing/  
pull-side transom fixing.

<sup>2)</sup> We recommend TS 98 XEA for exceptionally heavy doors  
and for doors that need to close against wind pressure.

The **closing speed** for the TS 92 XEA can be adjusted by using valves (1 + 2) in two independent areas. The **closing force** for the respective door width is variably adjusted via the lateral adjusting screw (3).

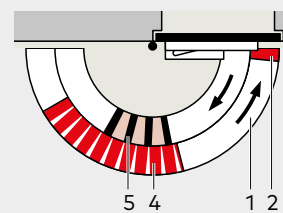
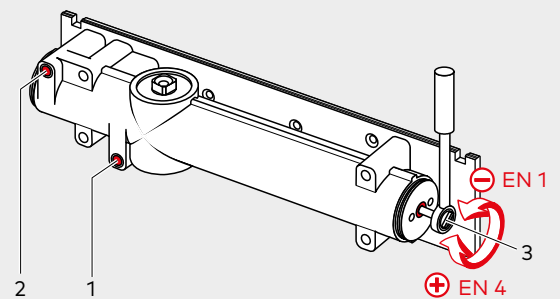

- 1 Variable closing speed from 180°-15°
- 2 Variable closing speed from 15°-0°
- 3 Variable closing force
- 4 Hold-open (option)
- 5 Cushioned limit stay (option)

### Torque curve

The heart-shape cam and the linear drive that characterizes all slide channel door closers ensures easy door operation thanks to a rapidly decreasing opening torque.

TS 92 XEA B Closing force adjustment, size EN 4

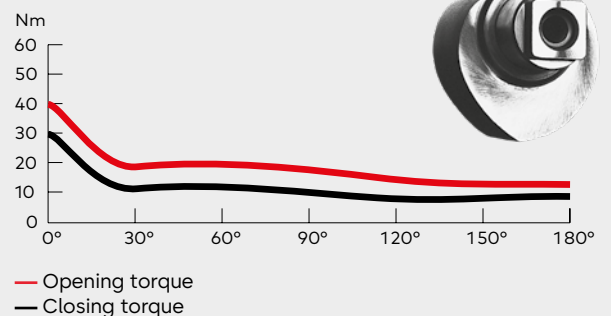

# Mounting points

## TS 92 XEA B Door installation, pull side

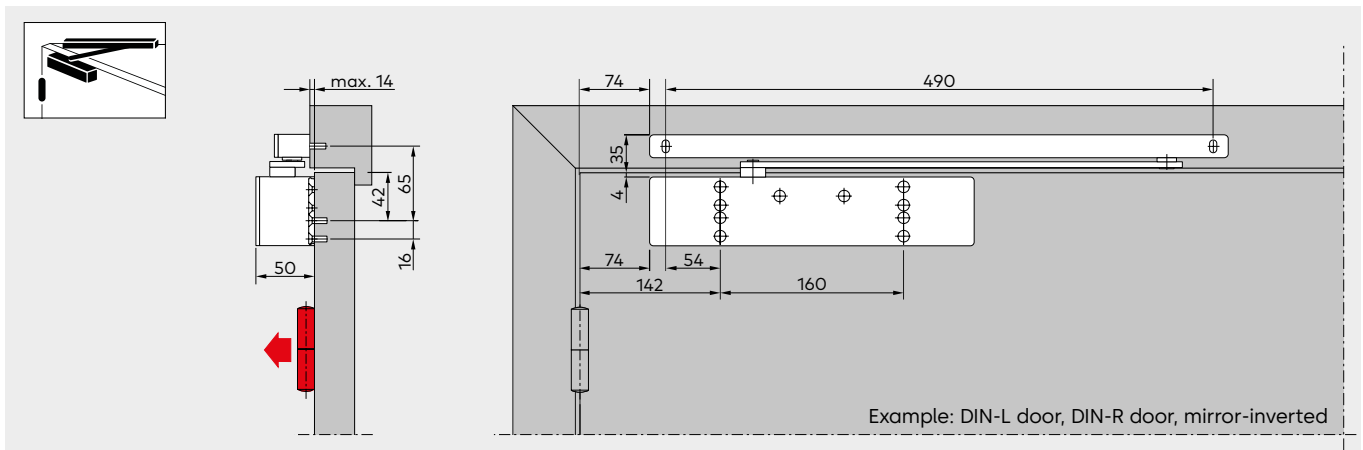

A 180° opening angle is possible in this installation type, provided that the appropriate construction conditions are met. In most cases, the door closer requires a wall recess for that purpose.

## TS 92 XEA B Transom installation, push side

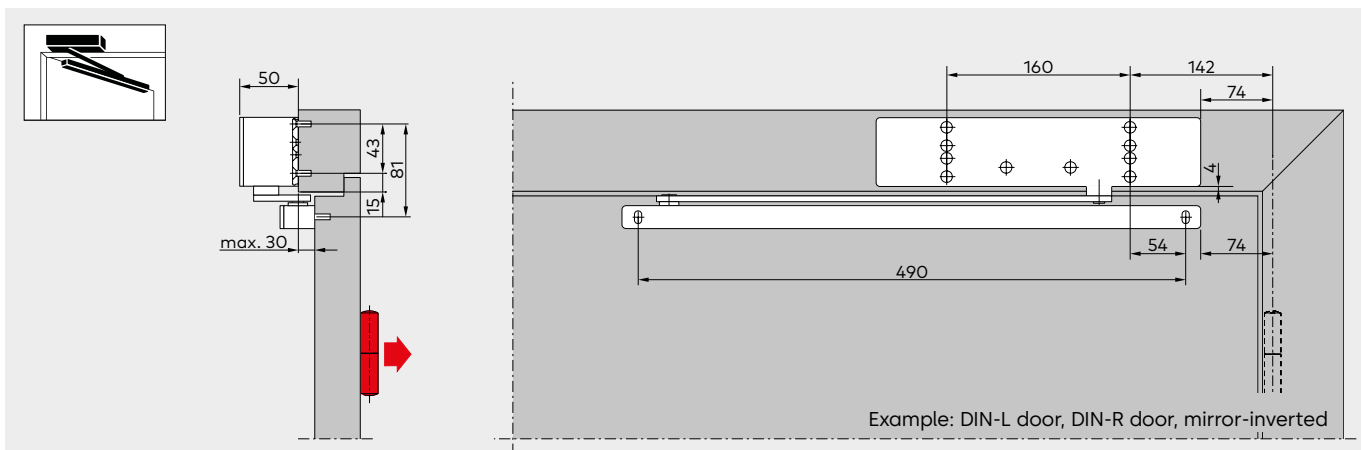

Depending on construction conditions, the door opening angle is limited to approx. 120° to 145°. To prevent damage to the door and door closer, we recommend using the opening restrictor or placing a door stop.

## TS 92 XEA G Door installation, push side

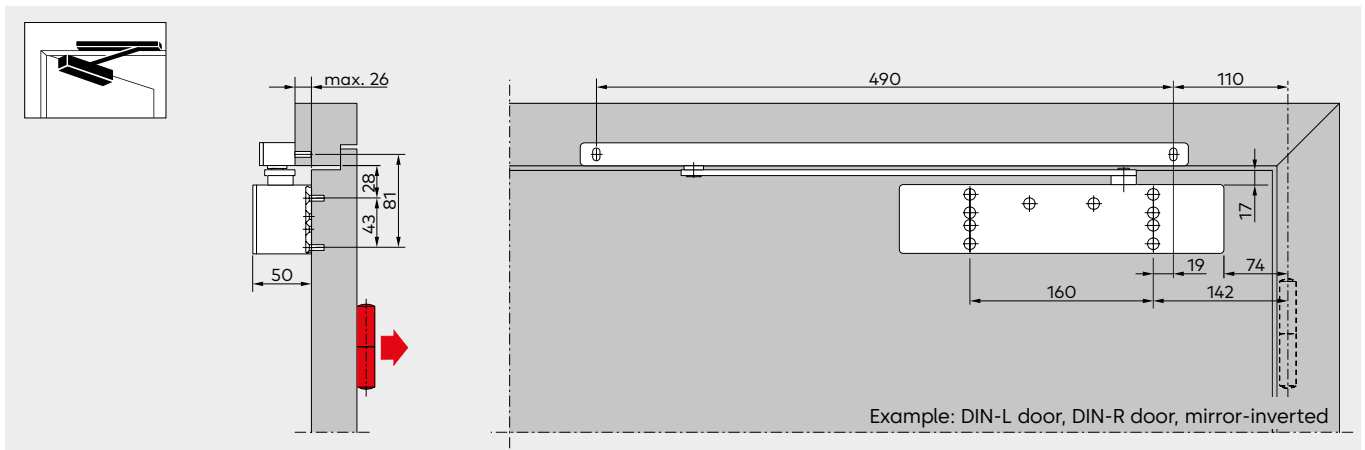

Depending on construction conditions, the door opening angle is limited to approx. 120° to 145°.

To prevent damage to the door and door closer, we recommend using the cushioned backstay or placing a door stop.

**A door stop must be placed on fire and smoke control doors.**

## TS 92 XEA G Transom installation, pull side

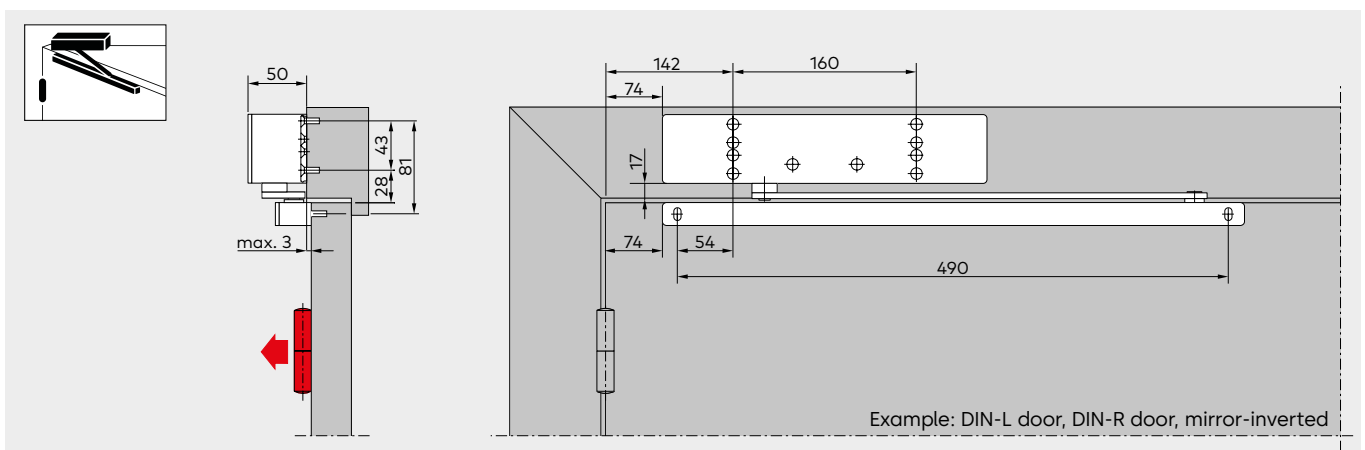

A 180° opening angle is possible in this installation type, provided that the appropriate construction conditions are met.

# G-N XEA und Zubehör

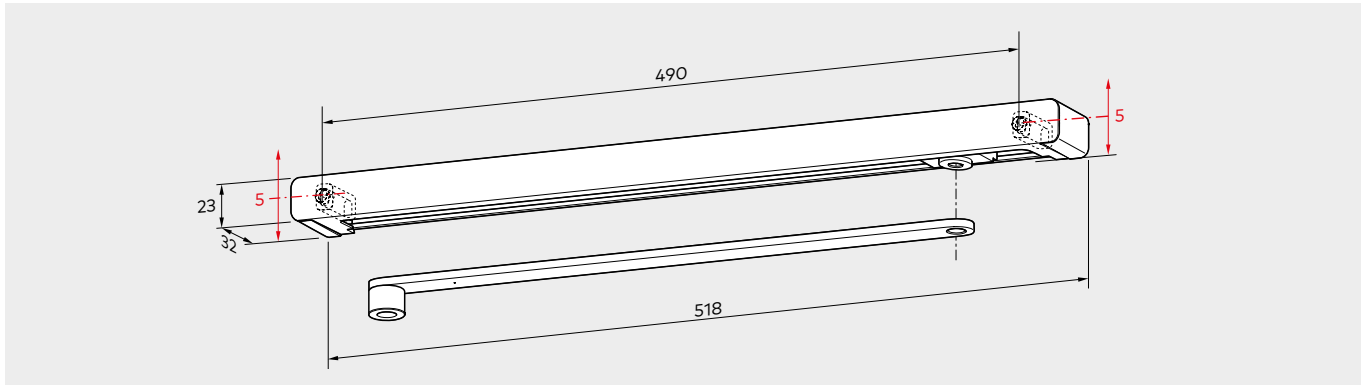

## G-N XEA

The **G-N XEA** main arm, slide channel, slide block, fixings, screws and end caps. The G-N XEA can be used for both DIN-L and DIN-R doors and may be combined with both door closers, pull side (B) and push side (G).

Thanks to oblong holes in the fixing pads, it is possible to compensate for deviations in the drill hole pattern and to keep the door closer body and slide channel perfectly parallel.

A G-N XEA design variant for direct transom installation is also available.

Optionally, the **G-N XEA** can be equipped with an RF hold-open device or limit stay.

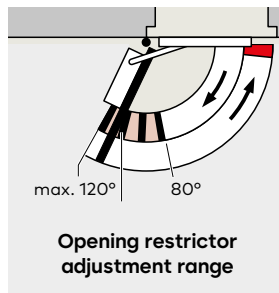
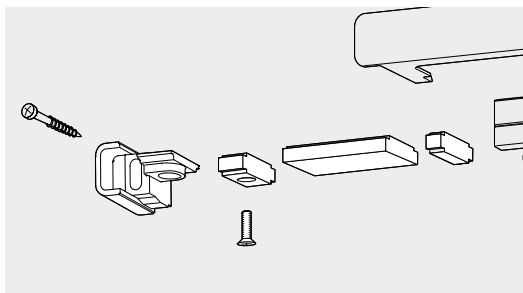

## Cushioned limit stay

Cushioned limit stay simply slides into the slide channel. Adjustable between 80° and max. 120°. Also suitable for retrofitting. Fitting a cushioned limit stay prevents doors which are opened normally from impacting against adjacent walls.

**The opening restrictor is not an overload protection mechanism and does not replace the door stop in many use cases.**

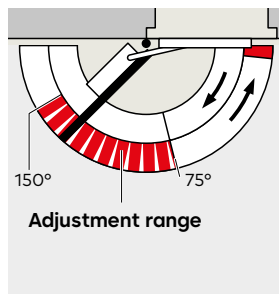
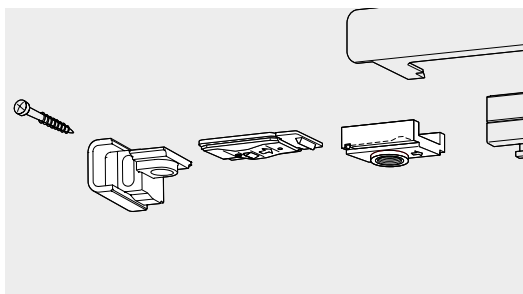

## Hold-open unit RF

Cushioned limit stay simply slides into the slide channel. The **RF** mechanical hold-open unit ensures that the doors are held open at precisely the correct angle – up to approx. 150° – without any fallback. The hold-open unit can be switched on and off by the user as required, and the pull-off force can be adjusted to suit each individual door situation. The RF hold-open unit is non-handed and can also be supplied for retrofitting to the slide channel at a later date.

**Not for fire and smoke control doors.**



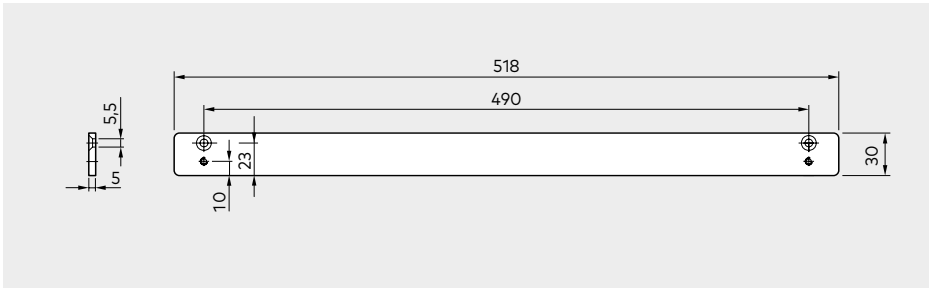

**30 mm mounting plate for G-N XEA**

For installing the slide channel on door frames where direct installation is not possible.

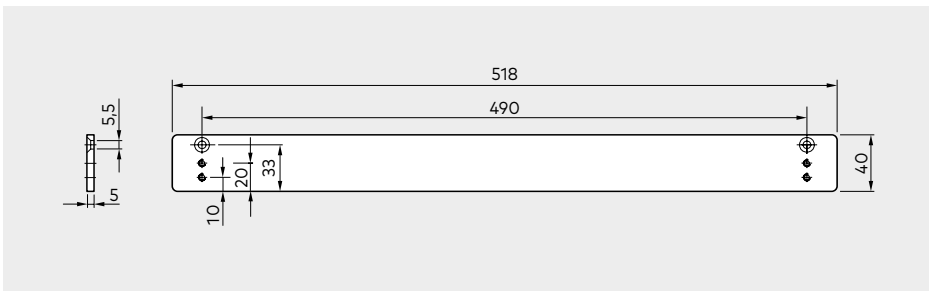
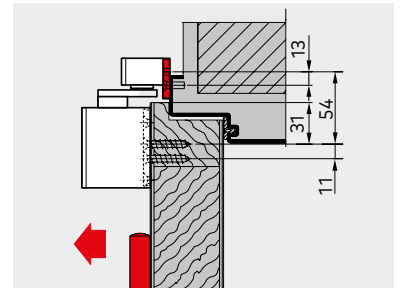

**40 mm mounting plate for G-N XEA**

For installing the slide channel on door frames where direct installation is not possible.

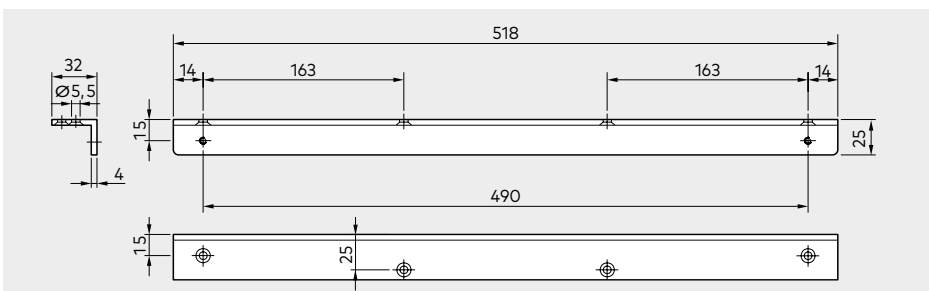
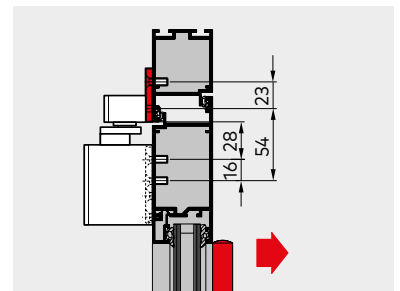

**Transom angle bracket for G-N XEA**

For installing the slide channel on door frames with a deep transom when installing on the push side. G-N XEA design variant for direct transom installation also available.

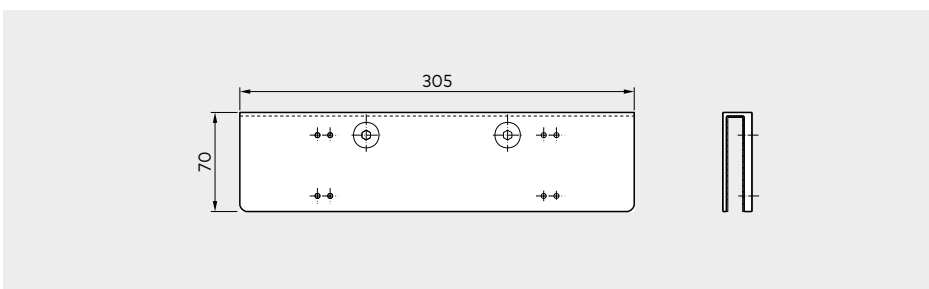
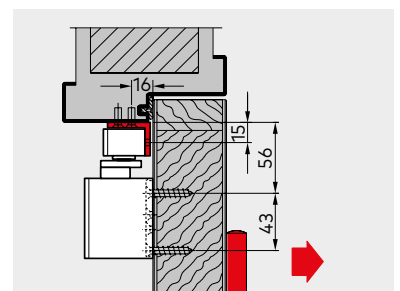





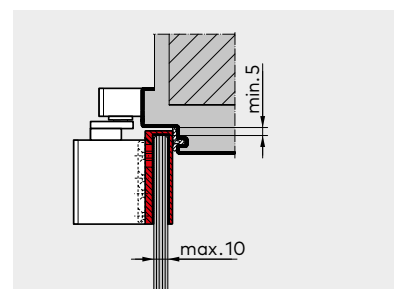

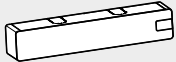

**Glass door shoe for TS 92 XEA**

For mounting the closing contact on the all-glass doors – no glass processing necessary, such as recesses and drilling.

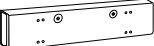

# Scope of delivery and accessories

	TS 92 XEA B	TS 92 XEA G	Mounting plate 30 mm for G-N XEA	Mounting plate 40 mm for G-N XEA	Transom angle bracket for G-N XEA	Cushioned limit stay for G-N XEA	Hold-open unit for G-N XEA
							
	EN size 1-4 ■ 422001xx	EN size 1-4 ■ 422101XX	574000xx	574100xx	574300xx	35800093	18570000
<b>G-N XEA</b>  □ 570100xx	□	■	□	■	△	△	△
<b>G-N XEA for transom installation</b>  □ 570400xx	□	■	□	■		△	△
<b>Glass door shoe for TS 92 XEA</b>  420002xx	△	△					

xx See color options for item number extension ■ Closing contact separate □ Rods separate △ Accessory

## xx Color options

- 01 Silver similar to RAL 9006 (P 600)
- 11 White similar to RAL 9016 (P 100)
- 10 White similar to RAL 9010 (P 210)
- 19 Black similar to RAL 9005 (P 190)
- 09 Other colors

TS 92 XEA also available in design\*

- 04 Stainless steel design (P 700)
- 05 Gold (P 750)

\* "Design" refers to the products' surface design.

## F Proof of suitability

The TS 92 XEA B and TS 92 XEA G door closers are tested according to EN 1154 by the National Materials Testing Office in Dortmund.

If the TS 92 XEA B is used in transom installation or the TS 92 XEA G is used, a certificate of suitability along with the respective fire and smoke control door is also required.

# Specification texts

## TS 92 XEA B, EN 1-4

Slide channel door closer according to EN 1154, with CE mark, in XEA design, including rapidly decreasing opening torque for easy door opening according to DIN SPEC 1104. Door leaf installation on the pull side, transom fixing on the push side. Closing speed can be conveniently adjusted from the front using valves in two independent areas. Mounting plate with universal hole group system. DIN-L and DIN-R are usable. Height-adjustable slide channel.

### Color

- Silver colored similar to RAL 9006 (P 600)
- White similar to RAL 9016 (P 100)
- White similar to RAL 9010 (P 210)
- Black similar to RAL 9005 (P 190)
- Stainless steel design
- Gold (P 750)
- Other colors

## TS 92 XEA G, EN 1-4

Slide channel door closer according to EN 1154, with CE mark, in XEA design, including rapidly decreasing opening torque for easy door opening according to DIN SPEC 1104. Door leaf installation on the push side, transom fixing on the pull side. Closing speed can be conveniently adjusted from the front using valves in two independent areas. Mounting plate with universal hole group system. DIN-L and DIN-R are usable. Height-adjustable slide channel.

### Color

- Silver colored similar to RAL 9006 (P 600)
- White similar to RAL 9016 (P 100)
- White similar to RAL 9010 (P 210)
- Black similar to RAL 9005 (P 190)
- Stainless steel design
- Gold (P 750)
- Other colors

## Our Sustainability Commitment

We are committed to foster a sustainable development along our entire value chain in line with our economic, environmental and social responsibilities toward current and future generations. Sustainability at product level is an important, future-oriented approach in the field of construction. In order to give quantified disclosures of a product's environmental impact through its entire life cycle, dormakaba provides Environmental Product Declarations (EPD), based on holistic life cycle assessments.

[www.dormakaba.com/sustainability](http://www.dormakaba.com/sustainability)



## Our offering

### Access Automation Solutions

Entrance Automation  
Entrance Security



### Access Control Solutions

Electronic Access & Data  
Escape and Rescue Systems  
Lodging Systems



### Access Hardware Solutions

Door Closers  
Architectural Hardware  
Mechanical Key Systems



### Services

Technical Support  
Installation and commissioning  
Maintenance and Repair



### Key & Wall Solutions

Key Systems  
Movable / Sliding Walls



### Safe Locks

Electronic Safe Locks  
Mechanical Safe Locks  
Boltworks and Accessories



### Glass systems

Manual door systems  
Glass fittings  
Horizontal Sliding Walls



WN 05457551532, EN, 05/23  
Subject to change without notice



[dormakaba.com](http://dormakaba.com)

**dormakaba**  
**International Holding AG**  
Hofwissenstrasse 24  
CH-8153 Rümlang  
T +41 44 818 90 11  
[info@dormakaba.com](mailto:info@dormakaba.com)  
**dormakaba.com**