

WN 058124-45532
09/11

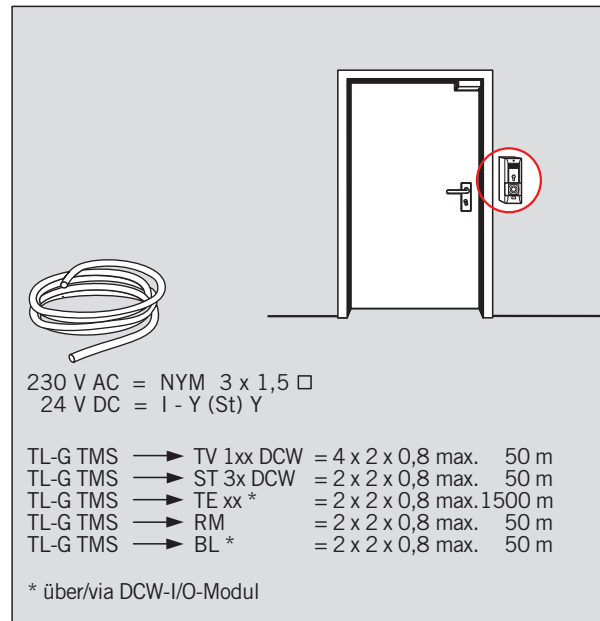
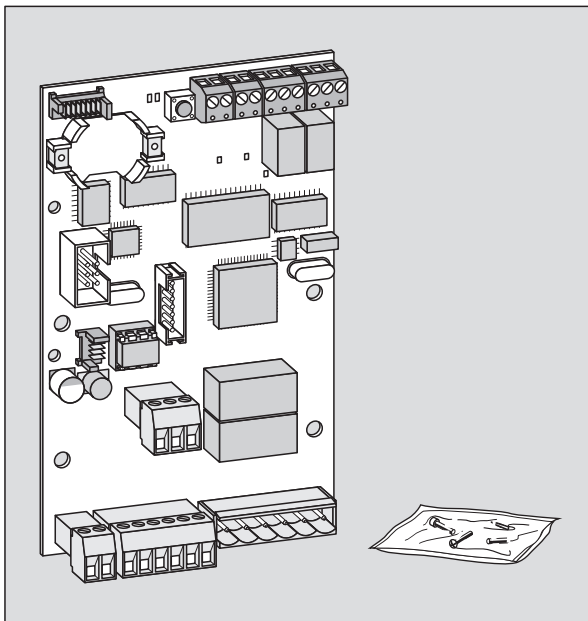

Elektrostatisch gefährdete Bauelemente

Static sensitive devices

Circuits sensibles à l'électricité statique

Elementi costruttivi sensibili all'elettricità statica

Elektrostatisch gevoelige componenten

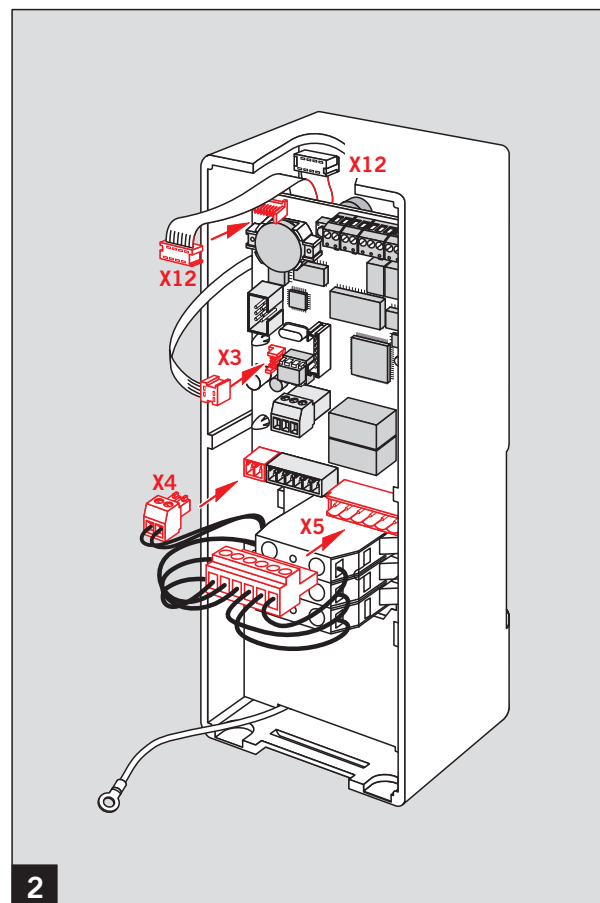
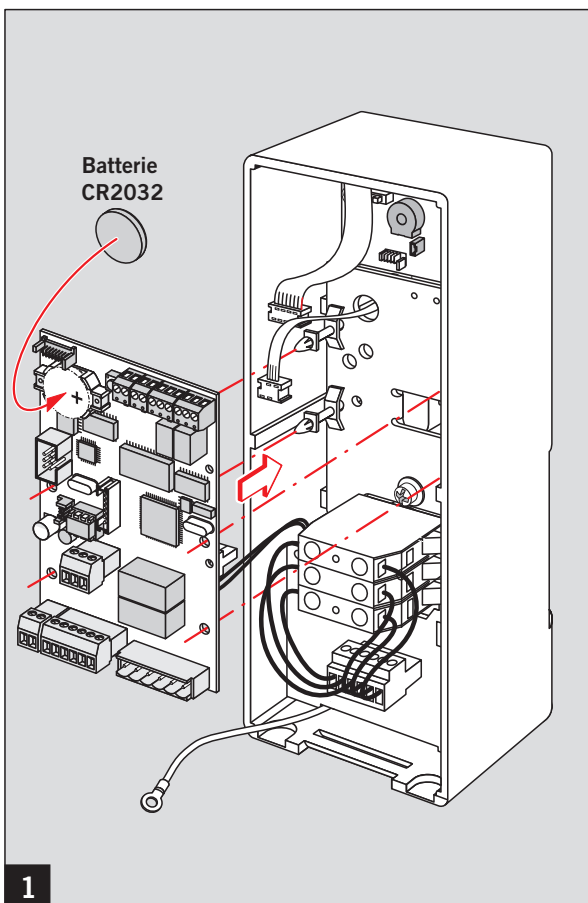

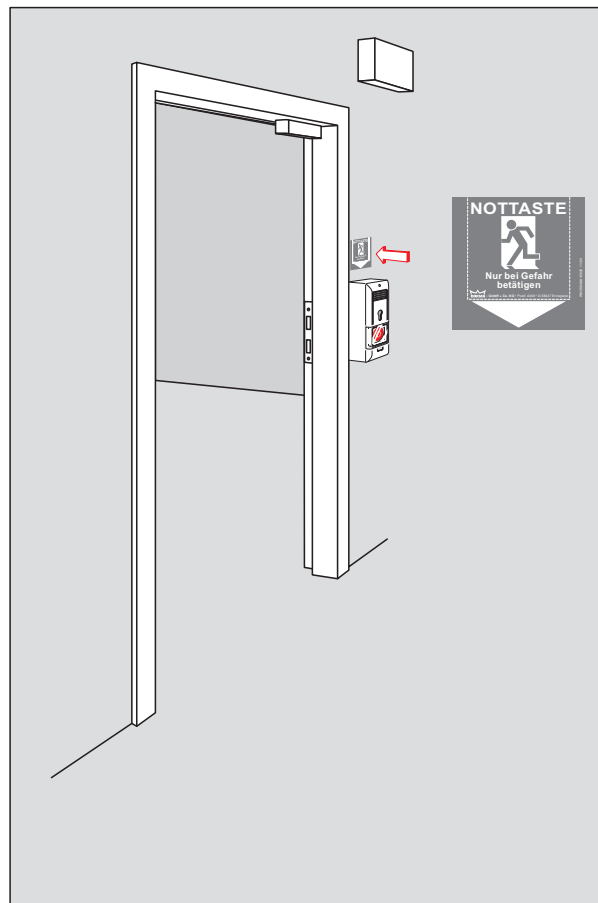
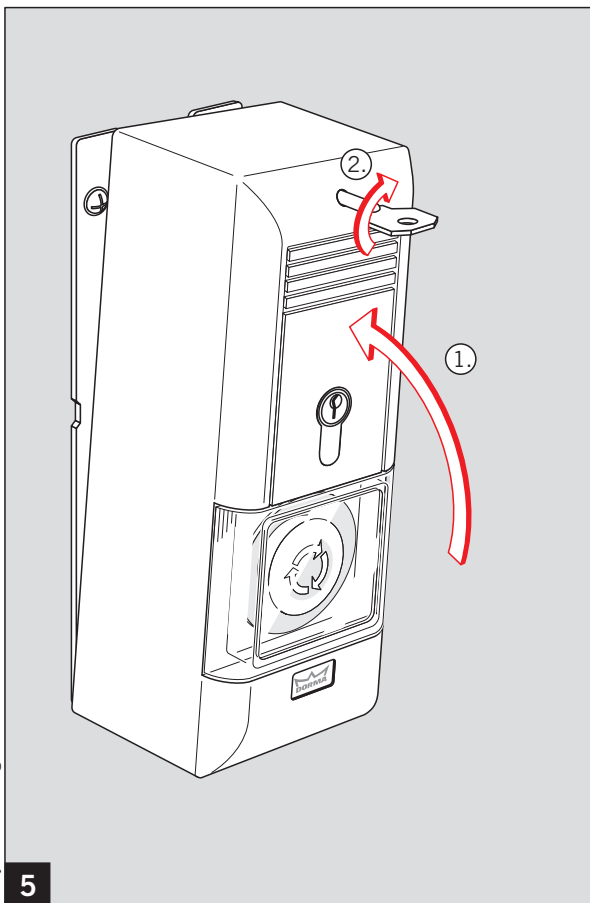
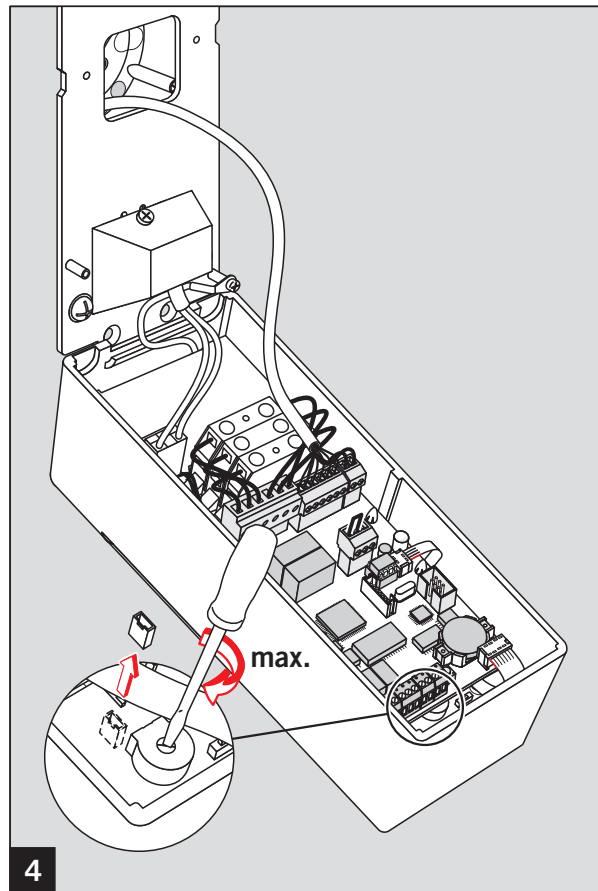
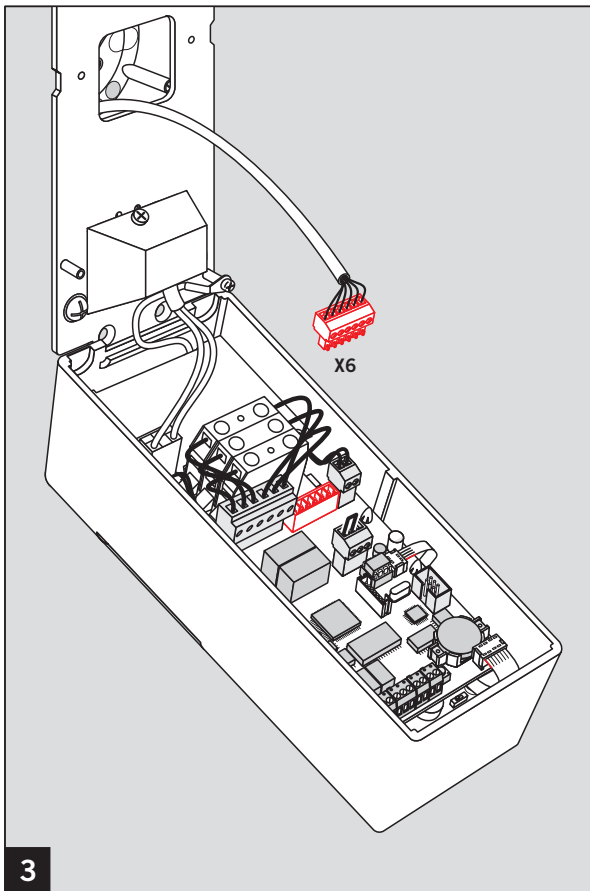

Änderungen vorbehalten
 Subject to change without notice