

CE	dormakaba Deutschland GmbH		19				
	Postfach 4009 58256 Ennepetal						
0432-CPR-00026-58	EN 1154:1996/A1:2002/AC:2006	3	8	3-6	1	1	4
	EN 1155: 1997/A1: 2002/AC:2006						

DOP_0172

Contents

1	About this document	2	4	Mounting	4
1.1	Contents and purpose	2	4.1	Mounting variants	4
1.2	Target group	2	4.2	Mounting the door closer and slide rail	4
1.3	Other applicable documents	2	4.3	Make electrical connections to the RMZ	4
1.4	Documents storage	2	4.4	Set DIP switches	4
1.5	Safety instructions	2	4.5	Apply voltage	5
1.6	Symbols used	2	4.6	Mount lever arm	5
1.6.1	Tool icons	2	4.7	Adjust door closer	5
1.7	Glossary	2	4.8	Mount the cladding	5
2	Safety	2	4.9	Set the doorstop	5
2.1	Intended use	2	4.10	Function test	5
2.2	Foreseeable misuse	3	4.10.1	Freewheel function	5
2.3	Prerequisites for the operation of hold-open systems	3	4.10.2	RMZ automatic door closing	5
2.4	Requirements for the electrical installation by the customer	3	5	Completion of mounting	5
3	Product description	3	5.1	Acceptance inspection	5
3.1	RMZ	3	6	Maintenance	6
3.2	DIP switch on the RMZ	3	7	Disassembly, recycling and disposal	6
3.2.1	Terminal assignment of the RMZ	4			
3.2.2	The RMZ's operating status display	4			
3.3	Optional components	4			
3.4	Technical data	4			
3.4.1	Door closer	4			
3.4.2	RMZ	4			

TS 97 FLR-K XEA

Mounting instructions

WN 059876 45532/13715

2019-08

EN

1 About this document

1.1 Contents and purpose

This manual describes the installation, startup, maintenance and disassembly of the TS 97 FLR-K XEA door closer. The manual's picture section is partly supported by text in this section of the manual.

1.2 Target group

The hold-open system's mounting, commissioning, maintenance and disassembly must only be carried out by qualified personnel that have been authorized by dormakaba. The acceptance inspection must only be carried out by qualified personnel certified for this by dormakaba. The operation of the hold-open system may be carried out by any person who is mentally and physically able of doing so.

1.3 Other applicable documents

The following documents belong to the unit's complete documentation and must be observed:

- Drilling template
- Picture section for mounting instructions
- RMZ/RM-ED connection diagrams
- Information sheet about the use of hold-open systems
- General design approval

1.4 Documents storage

This manual must be kept during the service life of the product and must be passed on with the product.

1.5 Safety instructions



DANGER

This signal word indicates a situation of immediate risk, which will lead to death or serious injury if not averted.



CAUTION

This signal word indicates a situation of potential risk, which could lead to minor or slight injury if not averted.



TIPS AND RECOMMENDATIONS

This signal word indicates useful information for efficient and trouble-free operation.

1.6 Symbols used



The picture number in the text document refers to an illustration in the picture section of the mounting instructions



Step-by-step graphics



Position numbers of components

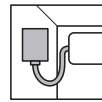

The icon indicates the installation stages of the supplied cable loop

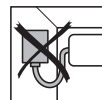

The icon indicates installation stages if the cable loop supplied is not mounted.

1.6.1 Tool icons



Allen wrench, e.g. wrench size 3

1.7 Glossary

- GS Slide rail
- HT Manual release button
- RM-N Smoke detector
- RMZ Smoke detector panel
- TS Door closer

2 Safety



DANGER

Danger to life through electric current

Works on electrical units must only be carried out by qualified electricians.

- Before starting work on electrical units and equipment, make sure that it is de-energized and that this condition is maintained for the duration of the work.

2.1 Intended use

The TS 97 FLR-K XEA is intended solely for the controlled closing of swing doors with the following properties:

- Maximum door leaf weight 180 kg
- Maximum door leaf weight 1,400 kg
- Maximum door opening angle when mounting the door closer on the hinge side approx. 145°
- Maximum door opening angle when mounting the door closer on the opposite side to the hinge approx. 105°

The door opening angle must be limited by a doorstop.

Observe country-specific regulations when using on fire barriers, fire protection doors and smoke barriers.

2.2 Foreseeable misuse

Do not control any further alarm devices with the hold-open system's fire detector, e.g. transmission device for fire alarms.

2.3 Prerequisites for the operation of hold-open systems

The use of hold-open systems is subject to special provisions due to the official approval regulations. These provisions relate in particular to acceptance, ongoing monitoring and maintenance. Follow the instructions in the information sheet on the use of hold-open systems.

Additional requirements apply for use as fire/smoke protection closure in conjunction with external RMZ and RM. A separate verification of suitability is required for the respective fire/smoke protection door.

1

If the lower surface of the ceiling on one or both sides of the door is more than 1 m above the lower edge of the lintel, an additional ceiling smoke detector must be mounted on each side of the door and must be connected with the RMZ. Measure the distance to the smoke-impermeable ceiling.

- ① RMZ
- ② TS 97 FL XEA
- ③ Connection box
- ④ Manual release button for door-holding devices. The manual release button must not be covered by the opened door.
- ⑤ Ceiling smoke detector

2.4 Requirements for the electrical installation by the customer

Carry out the following electrical installations before mounting the TS 97 FLR-K XEA:

- Connect the 230 V AC power supply to the RMZ. A circuit breaker B-10A/B-16A must be present in the supply circuit. The circuit breaker also serves as a disconnecting device to disconnect the RMZ from the power supply. The transverse section of the mains power supply must only be a max. 3 x 1.5 mm² (NYM).
- Connect the cables for the 24 V DC power supply from the RMZ to the TS 97 FLR-K XEA door closer. The supplied cable loop may only be used when the door closer is mounted on the hinge side.
- Connect the cables to the manual switches and/or additional RM-N smoke detectors.

3 Product description

The TS 97 FLR-K XEA is a slide rail door closer with freewheel function and smoke detector panel. The door closes automatically in the following cases:

- In case of power failure
- In case of fire
- In conjunction with an external manual switch.

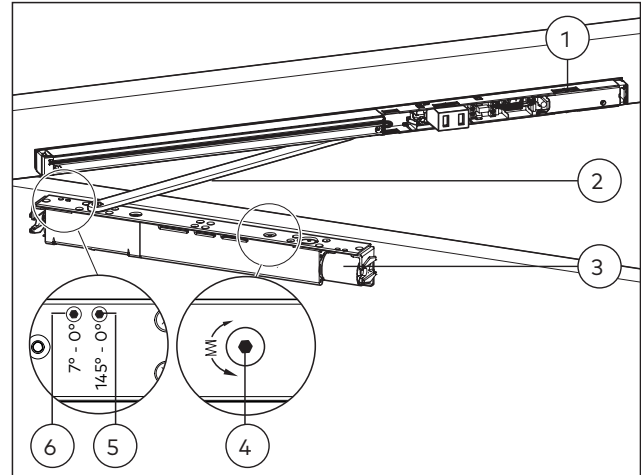

Fig. 1 TS 97 FLR-K XEA overview

- (1) Slide rail with RMZ (without cladding)
- (2) Lever arm
- (3) TS 97 FL XEA (without cladding)
- (4) Adjusting screw for adjusting the closing force
- (5) Valve for adjusting the closing speed
- (6) Valve for adjusting the end stop

3.1 RMZ

The RMZ supplies the door closer with 24 V DC voltage. In the event of an alarm or power failure, the RMZ switches off the power supply (tripping) and the door closes. The freewheel is reactivated again by a manual reset and a single opening of the door. An HT manual release button must be connected to the RMZ. Ceiling RM smoke detectors can be optionally connected. 2 LEDs show the current operating status. The RMZ is configured via the DIP switches.

3.2 DIP switch on the RMZ

The RMZ's functions are set via the DIP switches. Changes are only accepted after pressing the reset button (for settings see Chapter 4.3).

3.2.1 Terminal assignment of the RMZ





3 GND 12 + 24 V 14	Connection of external detectors with terminating resistor	Total output max. 9.8 W
1 + 4 -	Output 24 V DC door-holding device(s)	
2 10	 External manual release with terminating resistor (43 kOhm)	
7 NO 8 NC 9 C	Potential free changeover contact low voltage (SELV) 24 V AC/DC, 1 A	
11 16	Potential-free terminal Bus	

3.2.2 The RMZ's operating status display









Functions of the LEDs

LED on  LED off 

Operation indicator LED 1 (green/red)

Operation: green	
Smoke detector alarm: red	
Manual release button alarm: red	 

Service display LED 2 (yellow)

Maintenance due: flashing	  
Contamination: flashing	  
Malfunction: permanent	
Malfunction: flashing	 

Incorrect wiring to the ceiling smoke detector/manual release button

3.3 Optional components

- Concealed cable loop for the door closer's power supply via the door leaf, e.g. dormakaba KÜ 480 and LK12
- Additional smoke detector RM-N

3.4 Technical data

3.4.1 Door closer

Supply voltage operating voltage	24 V DC +/- 15 %
Power consumption	approx. 3 W
Ambient temperature:	-15°C to +40°C
Rel. humidity:	up to 93% (non condensing)
Protection class:	IP 54

3.4.2 RMZ

Input:	230 V AC +10 %/-15 % 120 mA/28 VA/50 Hz
Output:	24 V DC/460 mA/11 W
Protection class:	IP 30
Protection category:	II

Smoke switch:	24 V DC/50 mA
Temperature:	-20 °C/+40 °C
Rel. humidity:	max. 93 % without condensation

4 Mounting

The figures in the picture section of this manual show the mounting for DIN-L. For DIN-R, the instructions must be mirror-inverted.

4.1 Mounting variants

The TS 97 FLR-K XEA can be mounted DIN-L or DIN-R on the hinge side or opposite side to the hinge.

4.2 Mounting the door closer and slide rail

2-9

Carry out the mounting according to the enclosed illustrated instructions.

4.3 Make electrical connections to the RMZ

10

1. Connect the 230 V connection cable. To maintain the protection category II  (protective insulation), lay the 230-V supply with double insulation up to the connection terminal.
2. Ensure the strain relief of the mains power supply leading to the RMZ. The protective earth must not be used electronically. Connect the provided protective earth to the support terminal (PE).
3. Close the touch protection.
4. Screw the touch protection on.
5. Connect the cable from the door closer.
7. Connect the HT manual release button and the optional ceiling smoke detectors to the RMZ according to the enclosed wiring diagrams.

4.4 Set DIP switches

11

1. Set the DIP switches to the appropriate position.
 - 1 OFF = automatic reset (delivery state)
 - ON = manual reset (A manual reset is required for freewheel door closers) For this type of function, stick the enclosed label on the housing
- 2 OFF = 1-radial operation (line)
- ON = 2-radial operation (star)
- 3 OFF = without optional ceiling smoke detector
- ON = with optional ceiling smoke detector

- 4 OFF = without manual release button
ON = with manual release button

2. Press the reset button.

4.5 Apply voltage

12

1. Remove the red protection cover from the smoke detector unit.
2. Turn on the on-site power supply (230 V AC).
 - ▶ The operation indicator flashes green.

4.6 Mount lever arm

13



CAUTION

Risk of injury due to unintentional loosening of the screw connection on the lever arm

- Only use the self-locking screw supplied. If this screw is loosened during repair or maintenance work, the screw must be replaced by a new self-locking original screw.

Mount the lever arm according to the illustrated instructions and the mounting variant.

4.7 Adjust door closer

14

Adjust the door closer power.

15

1. Adjust the closing speed.
2. Adjust the end stop.

4.8 Mount the cladding

16 - 18

Carry out the mounting according to the enclosed illustrated instructions.

4.9 Set the doorstop

19

Set the doorstop according to the mounting variant and the structural conditions. The maximum opening angle must not be exceeded.

4.10 Function test

4.10.1 Freewheel function

The door can be opened and closed manually without resistance from the door closer.

4.10.2 RMZ automatic door closing



CAUTION

Risk of eye and respiratory injury

- Follow the application and safety instructions on the test gas and the safety data sheet.

20

1. Open the door.
2. Spray the test gas on the smoke detector according to the manufacturers' instructions.
 - ▶ The operation indicator switches to alarm (red).
 - ▶ The door closes.

During a manual reset:

When the test gas has dissipated, press the reset button to reactivate the freewheel function.

During an automatic reset:

The freewheel function is activated automatically 30 seconds after the test gas has dissipated.

5 Completion of mounting

If further structural work is carried out, protect the smoke detector from dust.

21

1. Disconnect the unit from the power supply.
2. Fit the provided dust cover.
3. Before the final commissioning, remove the dust cover and carry out a further function test according to chapter 4.10.

5.1 Acceptance inspection

After mounting, an acceptance inspection is to be carried out according to the inspection log for hold-open systems. The acceptance inspection must only be carried out by qualified personnel certified for this by dormakaba. Observe the instructions in the information sheet on the use of hold-open systems. The acceptance inspection must be documented in the inspection log for hold-open systems.

6 Maintenance

Maintenance may only be carried out by qualified personnel authorized by dormakaba. Observe the instructions in the information sheet on the use of hold-open systems.



Note

Dust deposits in the smoke detector may lead to false alarms.

- When used in rooms with large amounts of dust, shorten the prescribed maintenance intervals if necessary.

The smoke switch board must be replaced every 8 years according to DIN 14677. LED 2 lights up permanently to indicate that the replacement period has been reached.

7 Disassembly, recycling and disposal

Disassembly is carried out in reverse order to the mounting and must be carried out by qualified personnel.



DANGER

Danger to life through electric current

Works on electrical units must only be carried out by qualified electricians.

- Before starting work on electrical units and equipment, make sure that it is de-energized and that this condition is maintained for the duration of the work.



The product must be disposed of in an environmentally friendly manner. Electrical parts and batteries must not be disposed of with domestic waste. Dispose of electrotechnical parts and batteries in the designated acceptance and collection points. Refer to the statutory regulations for your country.

Translation of the original manual, subject to change without notice

dormakaba Deutschland GmbH

DORMA Platz 1 58256 Ennepetal Germany T: +49 2333 793-0 F: +49 2333 793-4950

www.dormakaba.com